



Agilent U8903A Audio Analyzer

Service Guide



Agilent Technologies

Notices

© Agilent Technologies, Inc. 2009-2012

No part of this manual may be reproduced in any form or by any means (including electronic storage and retrieval or translation into a foreign language) without prior agreement and written consent from Agilent Technologies, Inc. as governed by United States and international copyright laws.

Manual Part Number

U8903-90029

Edition

Third Edition, February 17, 2012

Agilent Technologies, Inc.
5301 Stevens Creek Blvd.
Santa Clara, CA 95051 USA

Warranty

The material contained in this document is provided “as is,” and is subject to change, without notice, in future editions. Further, to the maximum extent permitted by the applicable law, Agilent disclaims all warranties, either express or implied, with regard to this manual and any information contained herein, including but not limited to the implied warranties of merchantability and fitness for a particular purpose. Agilent shall not be liable for errors or for incidental or consequential damages in connection with the furnishing, use, or performance of this document or of any information contained herein. Should Agilent and the user have a separate written agreement with warranty terms covering the material in this document that conflict with these terms, the warranty terms in the separate agreement shall control.

Technology Licenses

The hardware and/or software described in this document are furnished under a license and may be used or copied only in accordance with the terms of such license.

Restricted Rights Legend

U.S. Government Restricted Rights. Software and technical data rights granted to the federal government include only those rights customarily provided to end user customers. Agilent provides this customary commercial license in Software and technical data pursuant to FAR 12.211 (Technical Data) and 12.212 (Computer Software) and, for the Department of Defense, DFARS 252.227-7015 (Technical Data - Commercial Items) and DFARS 227.7202-3 (Rights in Commercial Computer Software or Computer Software Documentation).

Safety Notices

CAUTION











A **CAUTION** notice denotes a hazard. It calls attention to an operating procedure, practice, or the likes of that, if not correctly performed or adhered to, could result in damage to the product or loss of important data. Do not proceed beyond a **CAUTION** notice until the indicated conditions are fully understood and met.

WARNING

A **WARNING** notice denotes a hazard. It calls attention to an operating procedure, practice, or the likes of that, if not correctly performed or adhered to, could result in personal injury or death. Do not proceed beyond a **WARNING** notice until the indicated conditions are fully understood and met.

Safety Symbols

The following symbols may appear on the instrument and in the documentation; they indicate precautions which must be taken to maintain safe operation of the instrument.

	Direct current (DC)		Equipment protected throughout by double insulation or reinforced insulation
	Alternating current (AC)		Off (supply)
	On (supply)		Caution, risk of electric shock
	Earth (ground) terminal		Caution, risk of danger (refer to this manual for specific Warning or Caution information)
	Protective conductor terminal		Frame or chassis terminal

Safety Considerations

The following general safety precautions must be observed during all phases of operation of this instrument. Failure to comply with these precautions or with specific warnings elsewhere in this manual violates safety standards of design, manufacture, and intended use of the instrument. Agilent Technologies, Inc. assumes no liability for the customer's failure to comply with these requirements.

WARNING

- **Ground the equipment.**
For Safety Class 1 equipment (equipment having a protective earth terminal), an uninterruptible safety earth ground must be provided from the mains power source to the product input wiring terminals or supplied power cable.
- **DO NOT operate the product in an explosive atmosphere or in the presence of flammable gases or fumes.** For continued protection against fire, replace the line fuse(s) only with fuse(s) of the same voltage and current rating and type. **DO NOT** use repaired fuses or short-circuited fuse holders.
- **Keep away from live circuits.**
Operating personnel must not remove equipment covers or shields. Procedures involving the removal of covers or shields are for use by service-trained personnel only. Under certain conditions, dangerous voltages may exist even with the equipment switched off. To avoid dangerous electric shock, **DO NOT** perform procedures involving cover or shield removal unless you are qualified to do so.
- **DO NOT operate damaged equipment.**
If the built-in safety protection features have been impaired through physical damage, excessive moisture, or any other reason, **REMOVE POWER** and do not use the product until safe operation is verified by service-trained personnel. If necessary, return the product to Agilent for service and repair to ensure that the safety features are maintained.
- **DO NOT service or adjust alone.**
Do not attempt any internal service or adjustment unless a person capable of rendering first aid and resuscitation is present.
- **DO NOT substitute parts or modify equipment.**
To avoid the occurrence of additional hazards, do not install substitute parts or perform any unauthorized modification to the product. Return the product to Agilent for service or repair to ensure that the safety features are maintained.

WARNING

- This equipment is under CAT 1 measurement category; do not connect the cable to MAIN.



CAT 1

Maximum Working Voltage: 200 Vp for altitude up to 3000 m

Maximum Transient Voltage: 1210 V

- Do not measure more than the rated voltage (as marked on the equipment).
-

CAUTION

- Use the device with the cables provided.
 - Repair or service that is not covered in this manual should only be performed by qualified personnels.
 - Observe all markings on the device before establishing any connection.
 - Always use dry cloth to clean the device. Do not use ethyl alcohol or any other volatile liquid to clean the device.
 - Do not permit any blockage of the ventilation holes of the device.
-

Environmental Conditions

This instrument is designed for indoor use and in an area with low condensation. The table below shows the general environmental requirements for this instrument.





Environmental condition	Requirement
Operating temperature	0 °C to 55 °C
Operating humidity	20% to 80% RH noncondensing at 40 °C
Storage temperature	–40 °C to 70 °C
Storage humidity	20% to 80% RH noncondensing at 65 °C

NOTE

The U8903A Audio Analyzer complies with the following safety and EMC requirements.

- IEC 61010-1:2001/EN 61010-1:2001 (2nd Edition)
- Canada: CAN/CSA-C22.2 No. 61010-1-04
- Canada: ICES/NMB-001:Issue 4, June 2006
- IEC 61326-1:2005/EN 61326-1:2006
- Australia/New Zealand: AS/NZS CISPR 11:2004
- USA: ANSI/UL std No. 61010-1:2004

Regulatory Markings

	<p>The CE mark is a registered trademark of the European Community. This CE mark shows that the product complies with all the relevant European Legal Directives.</p>
	<p>The C-tick mark is a registered trademark of the Spectrum Management Agency of Australia. This signifies compliance with the Australia EMC Framework regulations under the terms of the Radio Communication Act of 1992.</p>
<p>ICES/NMB-001</p>	<p>ICES/NMB-001 indicates that this ISM device complies with the Canadian ICES-001. Cet appareil ISM est conforme à la norme NMB-001 du Canada.</p>
	<p>This instrument complies with the WEEE Directive (2002/96/EC) marking requirement. This affixed product label indicates that you must not discard this electrical or electronic product in domestic household waste.</p>
	<p>The CSA mark is a registered trademark of the Canadian Standards Association.</p>
	<p>This symbol indicates the time period during which no hazardous or toxic substance elements are expected to leak or deteriorate during normal use. Forty years is the expected useful life of the product.</p>

Waste Electrical and Electronic Equipment (WEEE) Directive 2002/96/EC

This instrument complies with the WEEE Directive (2002/96/EC) marking requirement. This affixed product label indicates that you must not discard this electrical or electronic product in domestic household waste.

Product Category:

With reference to the equipment types in the WEEE directive Annex 1, this instrument is classified as a “Monitoring and Control Instrument” product.

The affixed product label is as shown below.



Do not dispose in domestic household waste.

To return this unwanted instrument, contact your nearest Agilent Service Center, or visit

www.agilent.com/environment/product

for more information.

Table of Contents

1 Performance Verification Overview

Introduction	2
Self-Test	3
Agilent Technologies Calibration Services	3
Calibration Interval	3
Recommended Test Equipment	4
Test Consideration	6

2 Performance Verification for Analog Generator

Introduction	8
Performance Verification	8
DC accuracy verification	8
AC accuracy and flatness verification	10
Frequency accuracy verification	12
Crosstalk verification	14
Distortion (THD+N) verification	16
Square wave rise time verification	18
Square wave amplitude accuracy verification	20

3 Performance Verification for Analog Analyzer

Introduction	24
Performance Verification	24
DC accuracy verification	24
AC accuracy and flatness verification	26
Frequency accuracy verification	29
Phase accuracy verification	31
Crosstalk verification	33

Distortion verification	35
Residual IMD verification	36
CMRR verification	38

4 Performance Verification for Digital Generator and Analyzer

U8903A Options	42
U8903A Option 113	42
U8903A Option 114	42
U8903A Option 115	42
Performance Verification	43
DSI master clock output frequency accuracy verification	43
Optical input sampling rate accuracy verification	45
Balanced input sampling rate accuracy verification	46
Balanced output level accuracy verification	48
Balanced output sampling rate accuracy verification	51
Unbalanced input sampling rate accuracy verification	53
Unbalanced output level accuracy verification	54
Unbalanced output sampling rate accuracy verification	57

5 U8903A Application Recovery

Overview	60
Application Recovery	61

6 Theory of Operation

Overview	68
System Block Level Theory	69
Front panel	70
Controller board	70
Power supply	70
LCD display sub-assembly	71
Carrier PCBA	71

Carrier PCBA level theory	72
Digital Audio	75

A Appendix A

Analog Generator Performance Verification	80
Test record for DC accuracy verification	80
Test record for AC accuracy verification	83
Test record for flatness verification	84
Test record for frequency accuracy verification	86
Test record for crosstalk verification	86
Test record for distortion verification	87
Test record for square wave rise time verification	87
Test record for square wave amplitude accuracy verification	88
Analog Analyzer Performance Verification	89
Test record for DC accuracy verification	89
Test record for AC accuracy verification	90
Test record for flatness verification	91
Test record for frequency accuracy verification	108
Test record for phase accuracy verification	108
Test record for crosstalk verification	109
Test record for distortion verification	109
Test record for residual IMD verification	109
Test record for CMRR verification	110

B Appendix B

Digital Generator and Analyzer Performance Verification	112
Test record for DSI master clock output frequency accuracy verification	112
Test record for optical input sampling rate accuracy verification	132

Test record for balanced input sampling rate accuracy verification	133
Test record for balanced output level accuracy verification	136
Test record for balanced output sampling rate accuracy verification	143
Test record for unbalanced input sampling rate accuracy verification	145
Test record for unbalanced output level accuracy verification	148
Test record for unbalanced output sampling rate accuracy verification	154

List of Figures

- Figure 1-1 Process flow for self-test, performance tests, and repair 2
- Figure 2-1 U8903A to digital multimeter connection for DC accuracy verification 9
- Figure 2-2 U8903A to digital multimeter connection for AC accuracy and flatness verification 10
- Figure 2-3 U8903A to frequency counter connection for frequency accuracy verification 12
- Figure 2-4 U8903A to audio analyzer connection for crosstalk verification 14
- Figure 2-5 U8903A to audio analyzer connection for distortion verification 16
- Figure 2-6 U8903A to oscilloscope connection for square wave rise time verification 18
- Figure 2-7 U8903A to digital multimeter connection for square wave amplitude accuracy verification 20
- Figure 3-1 Calibrator to U8903A connection for DC accuracy verification 25
- Figure 3-2 Calibrator to U8903A connection for AC accuracy and flatness verification 26
- Figure 3-3 Audio generator to frequency counter and U8903A connection for frequency accuracy verification 29
- Figure 3-4 Audio generator to U8903A connection for phase accuracy verification 32
- Figure 3-5 Audio generator to U8903A with terminator connection for crosstalk verification 33
- Figure 3-6 Audio generator to U8903A connection for distortion verification 35
- Figure 3-7 Audio generator to U8903A connection for residual IMD verification 37
- Figure 3-8 Audio generator to U8903A connection for CMRR verification 38
- Figure 4-1 Agilent 53132A to DSI MCLK output for DSI master clock output frequency accuracy verification 43
- Figure 4-2 SYS2722 Digital Audio to U8903A digital input for optical

- input sampling rate accuracy verification 45
- Figure 4-3 SYS2722 Digital Audio to U8903A digital input for balanced input sampling rate accuracy verification 46
- Figure 4-4 DSO8064A oscilloscope to U8903A digital output for balanced output level accuracy verification 48
- Figure 4-5 Agilent 53132A to U8903A digital output for balanced output sampling rate accuracy verification 51
- Figure 4-6 SYS2722 Digital Audio to U8903A digital input for unbalanced input sampling rate accuracy verification 53
- Figure 4-7 DSO8064A oscilloscope to U8903A digital output for unbalanced output level accuracy verification 54
- Figure 4-8 Agilent 53132A to U8903A digital output for unbalanced output sampling rate accuracy verification 57
- Figure 5-1 Select the external USB flash storage 61
- Figure 5-2 Create a DOS startup disk 62
- Figure 5-3 Root directory of the external USB flash storage 62
- Figure 5-4 System Bios Setup page 63
- Figure 5-5 Basic CMOS Configuration 64
- Figure 5-6 Pop up message to confirm application update 65
- Figure 6-1 U8903A system block diagram 69
- Figure 6-2 Simplified block diagram for generator 72
- Figure 6-3 Simplified block diagram for analyzer 73
- Figure 6-4 Digital audio interface block diagram 75
- Figure 6-5 Digital audio interface power supply and clock distribution 76

List of Tables

Table 1-1	Recommended equipment for performance verification tests	4
Table 2-1	DC accuracy specification	8
Table 2-2	AC accuracy and flatness specifications	10
Table 2-3	Frequency accuracy specifications	12
Table 2-4	Crosstalk specification	14
Table 2-5	Audio analyzer settings	15
Table 2-6	Distortion specification	16
Table 2-7	Square wave rise time specification	18
Table 2-8	Square wave amplitude accuracy specification	20
Table 3-1	DC accuracy specification	24
Table 3-2	AC accuracy and flatness specifications	26
Table 3-3	Measurement time settings	27
Table 3-4	Frequency accuracy specifications	29
Table 3-5	Phase accuracy specification	31
Table 3-6	Crosstalk specification	33
Table 3-7	Distortion specification	35
Table 3-8	Residual IMD specification	36
Table 3-9	CMRR specification	38
Table 4-1	Channel 1 and channel 2 vertical scale and vertical scale range	49
Table 4-2	Channel 1 vertical scale settings	55



1 Performance Verification Overview

Introduction	2
Self-Test	3
Agilent Technologies Calibration Services	3
Calibration Interval	3
Recommended Test Equipment	4
Test Consideration	6

This chapter provides an overview on performance verification of the U8903A. It also includes a list of recommended test equipment.

Introduction

This section provides a brief overview for verifying the performance of the U8903A. Performance verifications allow you to verify that the U8903A is operating within its published specifications.

Figure 1-1 illustrates the process flow for carrying out the self-test, performance tests, and repair.

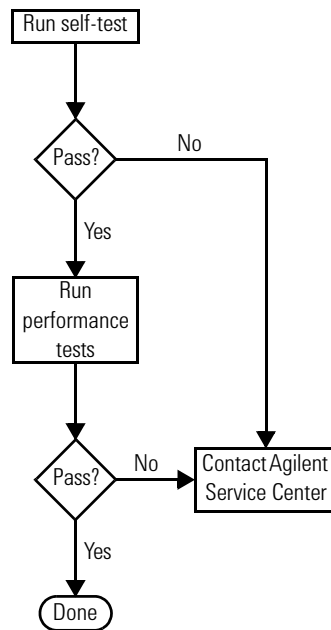

Figure 1-1 Process flow for self-test, performance tests, and repair

Self-Test

A brief power-on self-test occurs automatically whenever you turn on the U8903A. This limited test assures that the U8903A is capable of operation.

If the self-test fails, the error message can be accessed via the front panel. Alternatively, you can send the `SYSTem:ERRor?` query from the remote interface. Refer to the *U8903A Audio Analyzer Programmer's Reference* for more information on the error messages.

Self-test may be initiated remotely by sending the `*TST?` query to the U8903A. Always ensure that the self-test passes before proceeding with any performance verification test.

If all tests pass, you have a high confidence that the U8903A is operational.

Agilent Technologies Calibration Services

When your U8903A is due for calibration, contact your local Agilent Service Center for a low-cost recalibration. The U8903A is supported on automated calibration and adjustment systems, which allow Agilent to provide this service at competitive prices.

Calibration Interval

A one-year interval is adequate for most applications. Accuracy specifications are warranted only if calibration is made at regular calibration intervals. Accuracy specifications are not warranted beyond the one-year calibration interval. Agilent does not recommend extending calibration interval beyond the recommended calibration interval for any application.

Recommended Test Equipment

The recommended test equipment for performance verification tests is listed below. If the exact equipment is not available, substitute the calibration standards of equivalent requirement(s).

Table 1-1 Recommended equipment for performance verification tests

Equipment	Recommended model	Critical specification
Audio generator and analyzer	Audio Precision SYS-2722 ^[1]	<p>Generator:</p> <ul style="list-style-type: none"> • Voltage range of 0 Vrms to 10 Vrms or higher • Frequency range of 10 Hz to 100 kHz or higher • Residual THD+N of ≤ -107 dB (at 1 kHz, 1 Vrms, 20 Hz to 20 kHz bandwidth) <p>Analyzer:</p> <ul style="list-style-type: none"> • Voltage range of 0 Vrms to 10 Vrms or higher • Frequency range of 10 Hz to 100 kHz or higher • Residual THD+N of ≤ -101 dB (at 1 kHz, 1 Vrms, 20 Hz to 20 kHz bandwidth) • Crosstalk of ≤ -107 dB (from 20 Hz to 20 kHz)
Digital multimeter	Agilent 3458A	<ul style="list-style-type: none"> • DC voltage range of 0 V to 10 V or higher • AC voltage range of 0 Vrms to 10 Vrms or higher • 8.5-digit resolution or higher • DC voltage accuracy of 0.3% or higher • AC voltage accuracy of 0.02% or higher
Calibrator	Fluke 5720A	<ul style="list-style-type: none"> • DC voltage range of 0 V to 150 V or higher • AC voltage range of 0 Vrms to 150 Vrms or higher • Frequency range of 20 Hz to 100 kHz or higher • DC voltage accuracy of 0.2% or higher • AC voltage accuracy of 0.02% or higher
Frequency counter	Agilent 53132A Option 010	<ul style="list-style-type: none"> • Frequency range of 50 Hz to 80 kHz • Accuracy of 1 ppm or higher

Table 1-1 Recommended equipment for performance verification tests (continued)

Equipment	Recommended model	Critical specification
High impedance probe	Agilent E2697A	<ul style="list-style-type: none"> • Input voltage of 0 V to 10 V or higher • Input impedance of 1 MΩ or higher
Oscilloscope	Agilent DSO5014A	<ul style="list-style-type: none"> • Infiniium equivalent which is compatible with the high impedance probe • 1 GHz or higher
Oscilloscope	Agilent DSO8064A	–
50 Ω terminator	–	–
Computer	–	GPIB/USB/LAN and APIB connections
BNC cable	Agilent U8903A-101	1.2 m
XLR cable	Agilent U8903A-102	2 m
BNC-to-banana jack adapter	–	–
BNC-T adapter	–	–

[1] This instrument requires a computer to control its operation.

Test Consideration

For optimum performance, all procedures should comply with the following recommendations:

- Ensure that the calibration ambient temperature is stable and between 18 °C and 28 °C.
- Ensure the ambient relative humidity is less than 80%.
- Allow at least 30 minutes of warm-up period upon power on.
- Use shielded cables only. Keep the cables to connect the test setup as short as possible.
- In the event of a test failure, it is recommended to repeat the test to ensure that procedural error was not made.
- The verification and adjustment procedures are based on the assumption that the recommended test equipment is being used. Substituting with an alternative test equipment may require modification of some procedures.



2 Performance Verification for Analog Generator

Introduction	8
Performance Verification	8
DC accuracy verification	8
AC accuracy and flatness verification	10
Frequency accuracy verification	12
Crosstalk verification	14
Distortion (THD+N) verification	16
Square wave rise time verification	18
Square wave amplitude accuracy verification	20

The performance verification procedures described in this chapter verify that the analog generator of the U8903A is operating within its published specifications.



Introduction

This section lists the procedures to test the electrical performance of the U8903A analog generator using the published specifications given in the *U8903A Audio Analyzer User's Guide (U8903-90030)* as the performance standards.

If the analog generator fails any of the tests or if any abnormal test results are obtained, adjustment will need to be carried out accordingly.

NOTE

- Refer to [Chapter 1](#), “Recommended Test Equipment” for the list of recommended test equipment to be used in the performance tests.
- Use the test records given in “[Appendix A](#)” on page 79 to tabulate the results of the performance tests.

Performance Verification

DC accuracy verification

This test verifies the accuracy of the DC signal generated by the U8903A over a range of amplitudes using a digital multimeter to ensure that it is within the published specification.

Table 2-1 DC accuracy specification

DC accuracy specification	Equipment used
$\pm 1.5\%$	Digital multimeter

- 1 Connect the U8903A output channel to be tested to the digital multimeter via the Unbalanced connection as shown in [Figure 2-1](#). The BNC-to-banana jack adapter is used for this connection. Preset both the U8903A and digital multimeter.

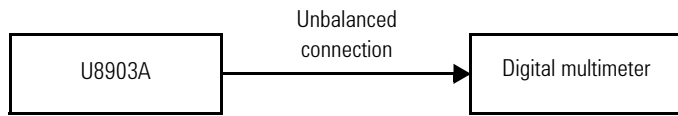

Figure 2-1 U8903A to digital multimeter connection for DC accuracy verification

- 2 Configure the digital multimeter as follows:
 - Measurement function: DC voltage
 - Level filter: Enabled
- 3 Configure the U8903A output channel to be tested as follows:
 - Connection type: Unbalanced
 - Output impedance: 50 Ω
 - Waveform: DC
- 4 Set the U8903A output channel to be tested to produce DC voltage with amplitude of V_{DUT} as given in the “[Test record for DC accuracy verification](#)” on page 80.
- 5 Enable the U8903A output channel.
- 6 Record the DC voltage measurement on the digital multimeter, V_{DMM} in the “[Test record for DC accuracy verification](#)” on page 80.
- 7 Compute the DC accuracy using the following equation:

$$DC\ accuracy = (V_{DUT} - V_{DMM}) / V_{DUT} \times 100$$
- 8 Repeat steps 4 through 7 for the rest of the V_{DUT} values to complete the verification of the U8903A output channel to be tested.
- 9 Repeat steps 1 through 8 to complete the verification of the other U8903A output channel.
- 10 Compare the recorded DC accuracy values to the specification. If the test fails, adjustment will need to be carried out accordingly.

AC accuracy and flatness verification

This test verifies the accuracy of the AC signal generated by the U8903A over a range of amplitudes swept over a set of frequencies using a digital multimeter to ensure that it is within the published specification.

The test results from the AC accuracy test will then be used to calculate the flatness of the U8903A in dB. Any failure in the AC accuracy test will directly impact its flatness and vice versa.

Table 2-2 AC accuracy and flatness specifications

AC accuracy specification	Flatness specification	Equipment used
$\pm 1\%$	± 0.01 dB (from 20 Hz to 20 kHz) ± 0.1 dB (from 5 Hz to 80 kHz)	Digital multimeter

- 1 Connect the U8903A output channel to be tested to the digital multimeter via the Unbalanced connection as shown in [Figure 2-2](#). The BNC-to-banana jack adapter is used for this connection. Preset both the U8903A and digital multimeter.

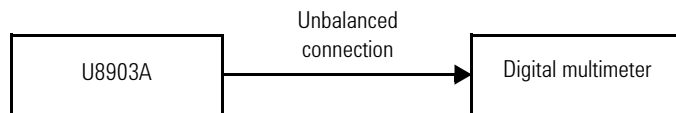

Figure 2-2 U8903A to digital multimeter connection for AC accuracy and flatness verification

- 2 Configure the digital multimeter as follows:
 - Measurement function: AC voltage
 - Measurement method: Synchronous sampling conversion
 - Level filter: Enabled

- 3 Configure the U8903A output channel to be tested as follows:
 - Connection type: Unbalanced
 - Output impedance: 50 Ω
 - Waveform: Sine
- 4 Set the U8903A output channel to be tested to produce a sine wave with amplitude of V_{DUT} and frequency of 1 kHz as given in the “[Test record for AC accuracy verification](#)” on page 83.
- 5 Enable the U8903A output channel.
- 6 Record the AC voltage measurement on the digital multimeter, V_{DMM} in the “[Test record for AC accuracy verification](#)” on page 83.
- 7 Compute the AC accuracy using the following equation:
$$AC\ accuracy = (V_{DUT} - V_{DMM}) / V_{DUT} \times 100$$
- 8 Repeat steps 4 through 7 for the rest of the V_{DUT} to complete the verification of the U8903A output channel to be tested.
- 9 Repeat steps 1 through 8 to complete the verification of the other U8903A output channel.
- 10 Disable the output of U8903A.
- 11 Set the U8903A output channel to be tested to produce a sine wave with amplitude of V_{DUT} and frequency of f_{DUT} as given in the “[Test record for flatness verification](#)” on page 84.
- 12 Enable the U8903A output channel.
- 13 Record the AC voltage measurement on the digital multimeter, V_{DMM} in the “[Test record for flatness verification](#)” on page 84.
- 14 Using the voltage measured at 1 kHz as reference, compute the flatness using the following equation. The frequency response is relative to the amplitude at 1 kHz.
$$Flatness = 20 \times \log_{10} (V_{DMM} \text{ at that particular } f_{DUT} / V_{DMM} \text{ at 1 kHz})$$

2 Performance Verification for Analog Generator

Performance Verification

- 15 Repeat steps 11 through 14 for the rest of the V_{DUT} and f_{DUT} combination to complete the verification of the U8903A output channel to be tested.
- 16 Repeat steps 11 through 15 to complete the verification of the other U8903A output channel.
- 17 Compare the recorded AC accuracy and flatness values to the specifications, adjustment will need to be carried out accordingly.

Frequency accuracy verification

This test verifies the frequency accuracy of the signal generated by the U8903A using a frequency counter to ensure that it is within the published specification.

Table 2-3 Frequency accuracy specifications

Frequency accuracy specification	Equipment used
± 5 ppm	Frequency counter

- 1 Connect the U8903A output channel to be tested to the frequency counter via the Unbalanced connection as shown in the following figure. Preset both the U8903A and frequency counter.

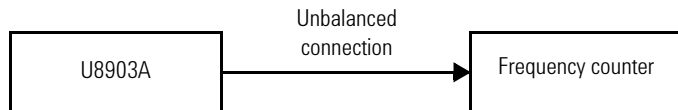

Figure 2-3 U8903A to frequency counter connection for frequency accuracy verification

- 2 Configure the frequency counter as follows:
 - Input impedance: 1 M Ω
 - Low pass filter: Enabled
 - Input coupling: DC
 - Auto trigger counting: Enabled
 - Trigger level: 0 V
 - Relative trigger level: 50%
 - Timing arming gate time: 2 s or 20 s
 - Statistical post processing: Enabled
 - Statistical display average type: Mean
 - Statistic measurement count: 1
- 3 Configure the U8903A output channel to be tested as follows:
 - Connection type: Unbalanced
 - Output impedance: 50 Ω
 - Waveform: Sine
- 4 Set the U8903A output channel to be tested to produce a sine wave with amplitude of 1 V_{rms} and frequency of f_{DUT} as given in the “[Test record for frequency accuracy verification](#)” on page 86.
- 5 Enable the U8903A output channel.
- 6 Record the frequency measurement on the frequency counter, f_{FC} in the “[Test record for frequency accuracy verification](#)” on page 86.
- 7 Compute the frequency accuracy using the following equation:
$$\text{Frequency accuracy} = (|f_{FC} - f_{DUT}| / f_{DUT}) \times 1000000$$
- 8 Repeat steps 4 through 7 for the rest of the f_{DUT} values to complete the verification of the U8903A output channel to be tested.
- 9 Repeat steps 1 through 8 to complete the verification of the other U8903A output channel.

2 Performance Verification for Analog Generator

Performance Verification

- 10 Compare the recorded frequency accuracy values to the specification. If the test fails, adjustment will need to be carried out accordingly.

Crosstalk verification

This test measures the leakage caused by stray capacitance and inductance coupling from one channel to another using an audio analyzer to ensure that it is within the published specification.

Table 2-4 Crosstalk specification

Crosstalk specification	Equipment used
≤ -101 dB (from 20 Hz to 20 kHz)	Audio analyzer
≤ -85 dB (from 20 kHz to 80 kHz)	

- 1 Connect the U8903A output channel to be tested and its adjacent output channel to channel A and channel B of the audio analyzer respectively via the Unbalanced connection as shown in [Figure 2-4](#). Preset both the U8903A and audio analyzer.

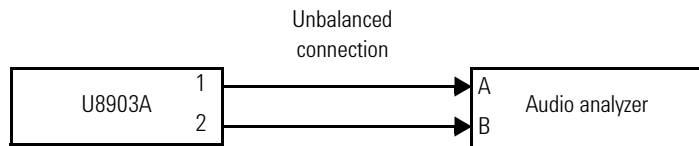

Figure 2-4 U8903A to audio analyzer connection for crosstalk verification

- 2 Configure the audio analyzer as follows:

Channel A

- Connection type: Unbalanced
- Input coupling: AC

Channel B

- Connection type: Unbalanced
- Input coupling: AC
- Function meter: FFT (graph mode)

Table 2-5 Audio analyzer settings

f_{DUT}	HiRes A/D Setting
≤ 2000	65536
5000	131072

- 3 Configure the U8903A output channel to be tested as follows:
 - Connection type: Unbalanced
 - Output impedance: 50 Ω
 - Waveform: Sine
- 4 Configure the adjacent U8903A output channel as follows:
 - Connection type: Unbalanced
 - Output impedance: 50 Ω
 - Waveform: Sine
- 5 Set the adjacent U8903A output channel to produce a sine wave with amplitude of 0 V_{rms} and frequency of 80 kHz.
- 6 Set the U8903A output channel to be tested to produce a sine wave with amplitude of 0.15V_{RMS} (-16.478 in dBV) and frequency of f_{DUT} as given in the “[Test record for crosstalk verification](#)” on page 86.
- 7 Enable the output for both channel 1 and channel 2.
- 8 Record the amplitude measurement on the Audio Analyzer, V_{meas} in the “[Test record for crosstalk verification](#)” on page 86.

2 Performance Verification for Analog Generator

Performance Verification

- 9 The crosstalk from the U8903A output channel to be tested to the adjacent output channel can be computed using the following equation:

$$\text{Crosstalk (in dBV)} = V_{meas} - (-16.478)$$

- 10 Repeat steps 6 through 9 for the rest of the V_{DUT} and f_{DUT} combinations to complete the verification of the U8903A output channel to be tested.
- 11 Repeat steps 1 through 10 to complete the verification of the other U8903A output channel.
- 12 Compare the recorded crosstalk measurement values to the specification. If the test fails, adjustment will need to be carried out accordingly.

Distortion (THD+N) verification

This test verifies if the residual THD+N of the U8903A is within the published specification using an audio analyzer with superior THD+N specification.

Table 2-6 Distortion specification

Distortion specification (at 1 kHz, 1 Vrms)	Equipment used
≤ -95 dB (for 20 Hz to 20 kHz bandwidth)	Audio analyzer

- 1 Connect the U8903A output channel to be tested to the audio analyzer via the Unbalanced connection as shown in Figure 2-5. Preset both the U8903A and audio analyzer.

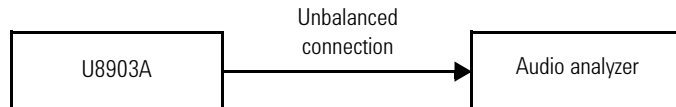

Figure 2-5 U8903A to audio analyzer connection for distortion verification

- 2** Configure the audio analyzer as follows:
 - Connection type: Unbalanced
 - Input coupling: DC
 - Function meter: THD+N ratio
 - Function meter unit: dB
 - Detector reading rate: 4 readings/sec
 - Low pass filter: 22 kHz
 - High pass filter: Disabled
- 3** Configure the U8903A output channel to be tested as follows:
 - Connection type: Unbalanced
 - Output impedance: 50 Ω
 - Waveform: Sine
- 4** Set the U8903A output channel to be tested to produce a sine wave with amplitude of 1 Vrms and frequency of 1 kHz.
- 5** Enable the U8903A output channel.
- 6** Record the THD+N ratio measurement on the audio analyzer in the [“Test record for distortion verification”](#) on page 87.
- 7** Repeat steps **1** to **6** to complete the verification of the other U8903A output channel.
- 8** Compare the recorded THD+N ratio measurement value to the specification. If the test fails, adjustment will need to be carried out accordingly.

Square wave rise time verification

In this test, the U8903A generates a square wave swept over a set of frequencies, and the rise time is measured using an oscilloscope to ensure that it is within the published specification. A high impedance probe is used to equip the oscilloscope with a 1 M Ω input impedance capability.

Table 2-7 Square wave rise time specification

Rise time specification	Equipment used
<2 μ s	Oscilloscope with high impedance probe

- 1 Connect the U8903A output channel to be tested to the high impedance probe via the Unbalanced connection as shown in [Figure 2-6](#). The high impedance probe is then connected to the oscilloscope. Preset both the U8903A and oscilloscope.

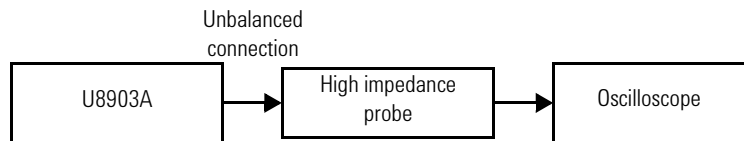

Figure 2-6 U8903A to oscilloscope connection for square wave rise time verification

- 2 Configure the oscilloscope as follows:
 - Input impedance: 1 M Ω
 - Trigger mode: Edge
 - Trigger slope: Positive
 - Time per division: 0.2 ms
 - Acquisition mode: Real time mode
 - Acquisition sample rate: 40G samples/sec
 - Interpolation filter: On

- 3** Configure the U8903A output channel to be tested as follows:
 - Connection type: Unbalanced
 - Output impedance: 50 Ω
 - Waveform: Square
- 4** Set the U8903A output channel to be tested to produce a square wave with frequency of 1 kHz and amplitude of V_{DUT} as given in the “[Test record for square wave rise time verification](#)” on page 87.
- 5** Enable the U8903A output channel.
- 6** Record the rise time measurement on the oscilloscope, t_{rise} in the “[Test record for square wave rise time verification](#)” on page 87.
- 7** Repeat steps **4** through **6** for the rest of the V_{DUT} values to complete the verification of the U8903A output channel to be tested.
- 8** Repeat steps **1** through **7** to complete the verification of the other U8903A output channel.
- 9** Compare the recorded rise time measurement values to the specification. If the test fails, adjustment will need to be carried out accordingly.

Square wave amplitude accuracy verification

This test verifies the amplitude accuracy of the square wave signal generated by the U8903A over a range of amplitudes using a digital multimeter to ensure that it is within the published specification.

Table 2-8 Square wave amplitude accuracy specification

Amplitude accuracy specification	Equipment used
$\pm 2\%$ (for 1 kHz)	Digital multimeter

- 1 Connect the U8903A output channel to be tested to the digital multimeter via the Unbalanced connection as shown in [Figure 2-7](#). Preset both the U8903A and digital multimeter.

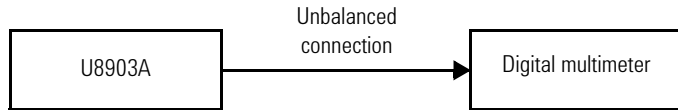

Figure 2-7 U8903A to digital multimeter connection for square wave amplitude accuracy verification

- 2 Configure the digital multimeter as follows:
 - Measurement function: AC voltage
 - Measurement method: Synchronous sampling conversion
 - Level filter: Enabled
- 3 Configure the U8903A output channel to be tested as follows:
 - Connection type: Unbalanced
 - Output impedance: 50 Ω
 - Waveform: Square

- 4** Set the U8903A output channel to be tested to produce a square wave with amplitude of V_{DUT} and frequency of 1 kHz as given in the “[Test record for square wave amplitude accuracy verification](#)” on page 88.
- 5** Enable the U8903A output channel.
- 6** Record the AC voltage measurement on the digital multimeter, V_{DMM} in the “[Test record for square wave amplitude accuracy verification](#)” on page 88.
- 7** Compute the square wave amplitude accuracy using the following equation:
$$AC\ accuracy = (V_{DUT} - V_{DMM}) / V_{DUT} \times 100$$
- 8** Repeat steps **4** through **7** for the rest of the V_{DUT} to complete the verification of the U8903A output channel to be tested.
- 9** Repeat steps **1** through **8** to complete the verification of the other U8903A output channel.
- 10** Compare the recorded amplitude measurement values to the specification. If the test fails, adjustment will need to be carried out accordingly.

2 Performance Verification for Analog Generator

Performance Verification

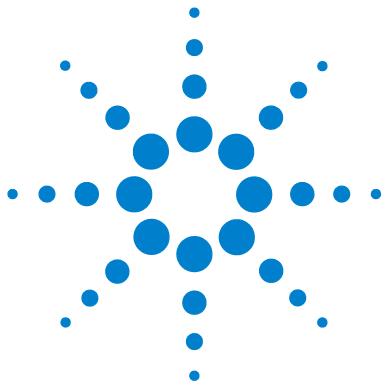

3 Performance Verification for Analog Analyzer

Introduction	24
Performance Verification	24
DC accuracy verification	24
AC accuracy and flatness verification	26
Frequency accuracy verification	29
Phase accuracy verification	31
Crosstalk verification	33
Distortion verification	35
Residual IMD verification	36
CMRR verification	38

The performance verification procedures described in this chapter verify that the analog analyzer of the U8903A is operating within its published specifications.



Introduction

This section lists the procedures to test the electrical performance of the U8903A analog analyzer using the published specifications given in the *U8903A Audio Analyzer User's Guide (U8903-90030)* as the performance standards.

If the analog analyzer fails any of the tests or if any abnormal test results are obtained, adjustment will need to be carried out accordingly.

NOTE

- Refer to [Chapter 1](#), “Recommended Test Equipment” for the list of recommended test equipment to be used in the performance tests.
- Use the test records given in “[Appendix A](#)” on page 79 to tabulate the results of the performance tests.

Performance Verification

DC accuracy verification

This test verifies the DC accuracy of the U8903A analyzer by measuring a range of DC voltage amplitudes supplied by a calibrator to ensure that it is within the published specification.

Table 3-1 DC accuracy specification

DC accuracy specification	Equipment used
±1%	Calibrator

- 1 Connect the calibrator to the U8903A input channel to be tested via the Unbalanced connection as shown in [Figure 3-1](#). The BNC-to-banana jack adapter is used for this connection. Preset both the U8903A and calibrator.

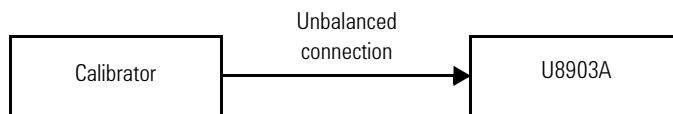

Figure 3-1 Calibrator to U8903A connection for DC accuracy verification

- 2 Configure the calibrator as follows:
 - Output function: DC voltage
- 3 Configure the U8903A input channel to be tested as follows:
 - Connection type: Unbalanced
 - Measurement function: DC voltage
 - Input coupling: DC
 - Measurement time: 1 s
 - Measurement bandwidth: High
- 4 Set the calibrator to produce DC voltage with amplitude of V_{IN} as given in the “[Test record for DC accuracy verification](#)” on page 89.
- 5 Enable the calibrator output.
- 6 Record the DC voltage measurement on the U8903A, V_{DUT} in the “[Test record for DC accuracy verification](#)” on page 89.
- 7 Compute the DC accuracy using the following equation:
$$DC\ accuracy = (V_{DUT} - V_{IN}) / V_{IN} \times 100$$
- 8 Repeat steps 4 through 7 for the rest of the V_{IN} values to complete the verification of the U8903A input channel to be tested.
- 9 Repeat steps 1 through 8 to complete the verification of the other U8903A input channel.
- 10 Compare the recorded DC accuracy values to the specification. If the test fails, adjustment will need to be carried out accordingly.

AC accuracy and flatness verification

This test verifies the AC accuracy of the U8903A analyzer by measuring a range of amplitudes swept over a set of frequencies supplied by a calibrator, to ensure that it is within the published specification. This test will be carried out for both low and high measurement bandwidth modes.

The test results from the AC accuracy test will then be used to calculate the flatness of the U8903A in dB. Any failure in the AC accuracy test will directly impact its flatness and vice versa.

Table 3-2 AC accuracy and flatness specifications

AC accuracy specification	Flatness specification	Equipment used
±1% (from 20 Hz to 100 kHz)	±0.01 dB – 0.001 dB/Hz (for <50 Hz) ±0.01 dB (from 50 Hz to 20 kHz) ±0.1 dB (from 20 kHz to 100 kHz)	Calibrator

- 1 Connect the calibrator to the U8903A input channel to be tested via the Unbalanced connection as shown in [Figure 3-2](#). The BNC-to-banana jack adapter is used for this connection. Preset both the U8903A and calibrator.

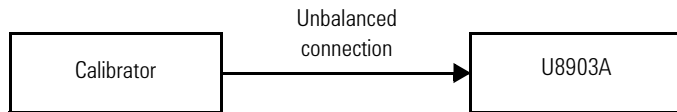

Figure 3-2 Calibrator to U8903A connection for AC accuracy and flatness verification

- 2 Configure the calibrator as follows:
 - Output function: AC voltage

3 Configure the U8903A input channel to be tested as follows:

- Connection type: Unbalanced
- Measurement function: AC voltage
- Input coupling: AC
- AC voltage detection mode: RMS
- Immediate trigger
- Measurement time:

Table 3-3 Measurement time settings

Sampling rate	Input frequency (Hz)	Measurement time setting
High	≤500	SENS:MTIM SP4
	>500	SENS:MTIM SP16
Low	≤500	SENS:MTIM SP2
	>500	SENS:MTIM SP16

- 4** Set the U8903A input channel to be tested to the low measurement bandwidth mode.
- 5** Set the calibrator to produce a sine wave with amplitude of V_{IN} and frequency of 1 kHz as given in the “[Test record for AC accuracy verification](#)” on page 90.
- 6** Enable the calibrator output.
- 7** Record the AC voltage measurement on the U8903A, V_{DUT} in the “[Test record for AC accuracy verification](#)” on page 90.
- 8** Compute the AC accuracy using the following equation:

$$AC\ accuracy = (V_{DUT} - V_{IN}) / V_{IN} \times 100$$
- 9** Repeat steps **5** through **8** for the rest of the V_{IN} to complete the verification of the U8903A input channel to be tested for the low measurement bandwidth mode.
- 10** Set the U8903A input channel to be tested to the high measurement bandwidth mode.

3 Performance Verification for Analog Analyzer

Performance Verification

- 11** Repeat steps **5** through **9** to complete the verification of the U8903A input channel to be tested for the high measurement bandwidth mode.
- 12** Repeat steps **1** through **11** to complete the verification of the other U8903A input channel.
- 13** Disable the output of U8903A.
- 14** Set the U8903A input channel to be tested to the low measurement bandwidth mode.
- 15** Set the calibrator to produce a sine wave with amplitude of V_{IN} and frequency of f_{IN} as given in the “[Test record for flatness verification](#)” on page 91.
- 16** Enable the U8903A output channel.
- 17** Record the AC voltage measurement on the U8903A, V_{DUT} in the “[Test record for flatness verification](#)” on page 91.
- 18** Using the voltage measured at 1kHz as reference, compute the flatness using the following equation. The frequency response is relative to the amplitude at 1 kHz.
$$Flatness = 20 \times \log_{10} (V_{DUT} \text{ at that particular } f_{IN} / V_{DUT} \text{ at } 1 \text{ kHz})$$
- 19** Repeat steps **15** through **18** for the rest of the V_{IN} and f_{IN} combinations to complete the verification of the U8903A input channel to be tested for the low measurement bandwidth mode.
- 20** Set the U8903A input channel to be tested to the high measurement bandwidth mode.
- 21** Repeat steps **15** through **19** to complete the verification of the U8903A input channel to be tested for the high measurement bandwidth mode.
- 22** Repeat steps **14** through **21** to complete the verification of the other U8903A input channel.
- 23** Compare the recorded AC accuracy and flatness values to the specifications. If the test fails, adjustment will need to be carried out accordingly.

Frequency accuracy verification

This test verifies the frequency accuracy of the U8903A analyzer by measuring a signal swept across a range of frequencies supplied by an audio generator, to ensure that it is within the published specification.

A frequency counter is used to characterize the frequency accuracy of the signal supplied by the audio generator before this signal can be used for the frequency accuracy measurement of the U8903A analyzer.

Table 3-4 Frequency accuracy specifications

Frequency accuracy specification	Equipment used
5 ppm	Audio generator Frequency counter

- 1 Connect the audio generator to the frequency counter and the U8903A input channel to be tested via the Unbalanced connection as shown in [Figure 3-3](#). Preset the U8903A, audio generator, and frequency counter.

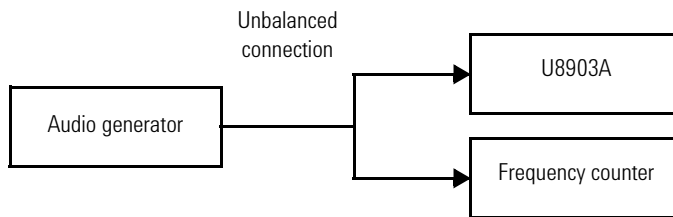

Figure 3-3 Audio generator to frequency counter and U8903A connection for frequency accuracy verification

- 2 Configure the audio generator as follows:
 - Connection type: Unbalanced
 - Output impedance: 20 Ω
 - Waveform: Sine D/A - Normal

3 Performance Verification for Analog Analyzer

Performance Verification

- 3 Configure the frequency counter as follows:
 - Input impedance: 1 M Ω
 - Low pass filter: Enabled
 - Input coupling: DC
 - Trigger level: 0 V
 - Relative trigger level: 50%
 - Timing aiming gate time: 2 s or 20 s
 - Statistical post processing: Enabled
 - Statistical display average type: mean
 - Statistic measurement count: 1
 - Auto trigger counting: Enabled
- 4 Configure the U8903A input channel to be tested as follows:
 - Connection type: Unbalanced
 - Measurement function: Frequency
 - Input coupling: AC
 - AC voltage detection mode: RMS
 - Measurement time: 1 s
 - Measurement bandwidth: High
- 5 Set the audio generator to produce a sine wave with amplitude of 1 V_{rms} and frequency of f_{IN} as given in the [“Test record for frequency accuracy verification”](#) on page 108.
- 6 Enable the audio generator output.
- 7 Wait 1 s to allow the audio generator to settle.
- 8 Record the frequency measurement on the frequency counter, f_{FC} and the U8903A, f_{DUT} in the [“Test record for frequency accuracy verification”](#) on page 108.
- 9 Compute the audio generator error, f_{error} using the following equation:

$$f_{error} = f_{FC} - f_{IN}$$

- 10** Compute the frequency accuracy of the U8903A using the following equation:

$$\text{Frequency accuracy} = (|f_{DUT} - f_{error} - f_{IN}| / f_{IN}) \times 1000000$$

- 11** Repeat steps **5** through **10** for the rest of the f_{IN} values to complete the verification of the U8903A input channel to be tested.
- 12** Repeat steps **1** through **11** to complete the verification of the other U8903A input channel.
- 13** Compare the recorded frequency accuracy values to the specification. If the test fails, adjustment will need to be carried out accordingly.

Phase accuracy verification

This test verifies the phase accuracy of the U8903A analyzer by measuring the phase difference of a sine wave generated by an audio generator to channels 1 and 2 of the U8903A respectively.

Table 3-5 Phase accuracy specification

Phase accuracy specification	Equipment used
$\pm 2^\circ$ (for <20 kHz)	Audio generator
$\pm 4^\circ$ (for <100 kHz)	

- 1** Connect the audio generator to the U8903A input channel 1 and 2 via the Unbalanced connection as shown in [Figure 3-4](#). Preset both the U8903A and audio generator.

3 Performance Verification for Analog Analyzer

Performance Verification

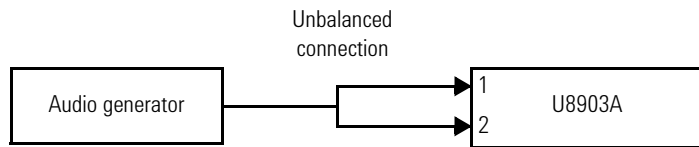

Figure 3-4 Audio generator to U8903A connection for phase accuracy verification

- 2** Configure the audio generator as follows:
 - Connection type: Unbalanced
 - Output impedance: 20 Ω
 - Waveform: Sine
- 3** Configure the U8903A input channel 1 as follows:
 - Connection type: Unbalanced
 - Measurement function: Phase (as reference channel)
 - Input coupling: AC
 - Measurement time: 1 s
 - Measurement bandwidth: High
- 4** Configure the U8903A input channel 2 as follows:
 - Connection type: Unbalanced
 - Measurement function: Phase
 - Input coupling: AC
 - Measurement time: 1 s
 - Measurement bandwidth: High
- 5** Set the audio generator to produce a sine wave with amplitude of 1 V_{rms} and frequency of f_{IN} as given in the “[Test record for phase accuracy verification](#)” on page 108.
- 6** Enable the audio generator output.
- 7** Record the phase measurement on the U8903A in the “[Test record for phase accuracy verification](#)” on page 108.
- 8** Repeat steps **5** through **7** for the rest of the f_{IN} values to complete the verification of the U8903A input channel 2.

- 9 Compare the recorded phase accuracy values to the specification. If the test fails, adjustment will need to be carried out accordingly.

Crosstalk verification

This test measures the leakage caused by stray capacitance and inductance coupling from one channel to another, to ensure that it is within the published specification. An audio generator is used to generate a sine wave to the U8903A for the crosstalk measurement.

Table 3-6 Crosstalk specification

Crosstalk specification	Equipment used
≤ -101 dB (from 20 Hz to 20 kHz)	Audio generator 50 Ω terminator

- 1 Connect the audio generator to the U8903A input channel to be tested via the Unbalanced connection as shown in [Figure 3-5](#). The BNC-to-banana jack adapter is used for this connection. Terminate the adjacent U8903A input channel with a 50 Ω terminator. Preset both the U8903A and audio generator.

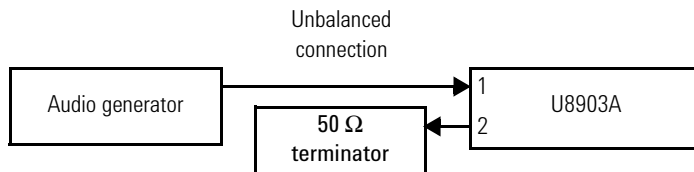

Figure 3-5 Audio generator to U8903A with terminator connection for crosstalk verification

3 Performance Verification for Analog Analyzer

Performance Verification

- 2** Configure the audio generator as follows:
 - Connection type: Unbalanced
 - Output impedance: 20 Ω
 - Waveform: Sine
- 3** Configure the U8903A input channel to be tested as follows:
 - Connection type: Unbalanced
 - Measurement function: Crosstalk (channel driven)
 - Input coupling: AC
 - Measurement time: 1 s
 - Measurement bandwidth: High
- 4** Configure the adjacent U8903A input channel as follows:
 - Connection type: Unbalanced
 - Measurement function: Crosstalk (channel measured)
 - Input coupling: AC
 - Measurement time: 1 s
 - Measurement bandwidth: High
- 5** Set the audio generator to produce a sine wave with amplitude of 1 V_{RMS} and frequency of f_{IN} as given in the “[Test record for crosstalk verification](#)” on page 109.
- 6** Enable the audio generator output.
- 7** Record the crosstalk measured by the adjacent U8903A input channel in the “[Test record for crosstalk verification](#)” on page 109.
- 8** This measurement will be the crosstalk from the U8903A input channel to be tested to the adjacent input channel.
- 9** Repeat steps **5** through **7** for the rest of f_{IN} to complete the verification of the U8903A input channel to be tested.
- 10** Repeat steps **1** through **8** to complete the verification of the other U8903A input channel.
- 11** Compare the recorded crosstalk measurement values to the specification. If the test fails, adjustment will need to be carried out accordingly.

Distortion verification

This test verifies the THD+N performance of the U8903A analyzer due to harmonics and wideband noise, to ensure that it is within the published specification. An audio generator with superior THD+N specification is used to generate a sine wave to the U8903A for the THD+N ratio measurement.

Table 3-7 Distortion specification

Distortion specification (at 1 kHz, 1 Vrms)	Equipment used
≤ -101 dB (for 20 Hz to 20 kHz bandwidth)	Audio generator

- 1 Connect the audio generator to the U8903A input channel to be tested via the Unbalanced connection as shown in [Figure 3-6](#). Preset both the U8903A and audio generator.

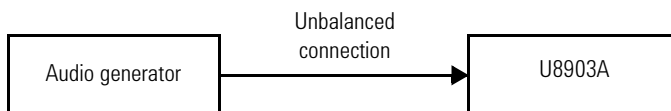

Figure 3-6 Audio generator to U8903A connection for distortion verification

- 2 Configure the audio generator as follows:
 - Connection type: Unbalanced
 - Output impedance: 20 Ω
 - Waveform: Sine

3 Performance Verification for Analog Analyzer

Performance Verification

- 3 Configure the U8903A input channel to be tested as follows:
 - Connection type: Unbalanced
 - Measurement function: THD+N ratio
 - Input coupling: AC
 - Measurement time: 1 s
 - Measurement bandwidth: Low
 - Low pass filter: 20 kHz
- 4 Set the audio generator to produce a sine wave with amplitude of 1 Vrms and frequency of 1 kHz.
- 5 Enable the audio generator output.
- 6 Record the THD+N ratio measurement on the U8903A in the “[Test record for distortion verification](#)” on page 109.
- 7 Repeat steps 1 through 6 to complete the verification of the other U8903A input channel.
- 8 Compare the recorded THD+N ratio measurement value to the specification. If the test fails, adjustment will need to be carried out accordingly.

Residual IMD verification

This test verifies the residual IMD performance of the U8903A analyzer by measuring a two-tone signal supplied by an audio generator, to ensure that it is within the published specification.

Table 3-8 Residual IMD specification

Residual IMD specification	Equipment used
≤0.0025% (−92 dB)	Audio generator

- 1 Connect the audio generator to the U8903A input channel to be tested as shown in [Figure 3-7](#). Preset both the U8903A and audio generator.

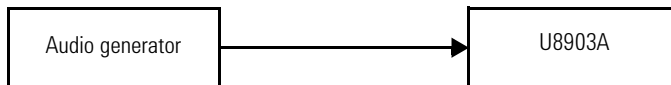

Figure 3-7 Audio generator to U8903A connection for residual IMD verification

- 2 Configure the audio generator as follows:
 - Output impedance: 20 Ω (for the Unbalanced output), 40 Ω (for the Balanced output)
 - Waveform: Dual sine
- 3 Configure the U8903A input channel to be tested as follows:
 - Measurement function: SMPTE IMD
 - Input coupling: AC
 - Measurement time: 1 s
 - Measurement bandwidth: High
- 4 Set the U8903A input channel to be tested to use the Unbalanced connection.
- 5 Set the audio generator to produce a dual sine wave with Profile 1 as given in the [“Test record for residual IMD verification”](#) on page 109.
- 6 Enable the audio generator output.
- 7 Record the SMPTE IMD measurement on the U8903A in the [“Test record for residual IMD verification”](#) on page 109.
- 8 This measurement will be the residual IMD of the U8903A analyzer in dB.
- 9 Repeat steps **5** through **7** for the rest of the profiles to complete the verification of the U8903A input channel to be tested with the Unbalanced connection.

3 Performance Verification for Analog Analyzer

Performance Verification

- 10 Set the U8903A input channel to be tested to use the Balanced connection.
- 11 Repeat steps 5 through 7 for the rest of the profiles to complete the verification of the U8903A input channel to be tested with the Balanced connection.
- 12 Repeat steps 1 through 10 to complete the verification of the other U8903A input channel.
- 13 Compare the recorded residual IMD measurement values to the specification. If the test fails, adjustment will need to be carried out accordingly.

CMRR verification

CMRR is the ability of the Balanced U8903A input channel to reject in-phase noise.

This test verifies the CMRR performance of the U8903A analyzer by measuring the CMTST signal supplied by an audio generator, to ensure that it is within the published specification.

Table 3-9 CMRR specification

Distortion specification (at 1 kHz, 1 Vrms)	Equipment used
≤ -101 dB (for 20 Hz to 20 kHz bandwidth)	Audio generator

- 1 Connect the audio generator to the U8903A input channel to be tested via the Balanced connection as shown in [Figure 3-8](#). Preset both the U8903A and audio generator.

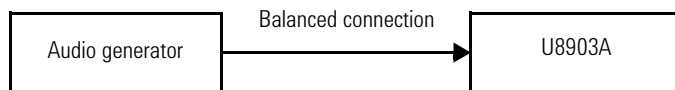

Figure 3-8 Audio generator to U8903A connection for CMRR verification

- 2 Configure the audio generator as follows:
 - Connection type: Balanced
 - Output impedance: 40 Ω
 - Waveform: Sine
- 3 Configure the U8903A input channel to be tested as follows:
 - Connection type: Balanced
 - Measurement function: FFT (graph mode)
 - Input coupling: DC
 - Display analysis mode: FFT magnitude
 - Waveform points: 32768
 - Synchronous averaging: 1
 - Measurement bandwidth: High
 - X-axis left limit: 20 Hz
- 4 Set the U8903A input channel to be tested to use the input range of R_{IN} .
- 5 Set the audio generator to produce a 1 V_{rms} CMTST signal with frequency of f_{IN} as given in the “[Test record for CMRR verification](#)” on page 110.
- 6 Enable the audio generator output.
- 7 Using the marker function, place marker 1 at frequency point f_{IN} and obtain the amplitude at this point.
- 8 Using the peak search function, obtain the highest amplitude at frequency range $f_{IN} \pm 95$ Hz and record the amplitude measurement in the “[Test record for CMRR verification](#)” on page 110.
- 9 Compute the CMRR (dB) using the following equation.
$$CMRR = -V_{DUT}$$
- 10 Record the CMRR measurement on the U8903A in the “[Test record for CMRR verification](#)” on page 110.
- 11 Repeat steps 4 through 10 for the rest of the R_{IN} and f_{IN} combinations to complete the verification of the U8903A input channel to be tested.

3 Performance Verification for Analog Analyzer

Performance Verification

- 12** Repeat steps **1** through **11** to complete the verification of the other U8903A input channel.
- 13** Compare the recorded CMRR values to the specification. If the test fails, adjustment will need to be carried out accordingly.

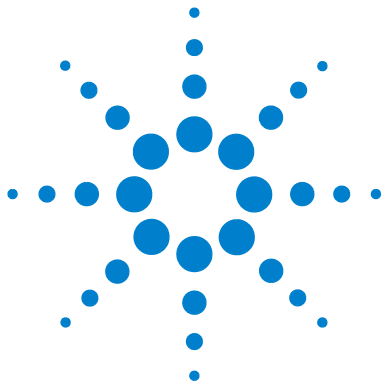

4 Performance Verification for Digital Generator and Analyzer

U8903A Options	42
U8903A Option 113	42
U8903A Option 114	42
U8903A Option 115	42
Performance Verification	43
DSI master clock output frequency accuracy verification	43
Optical input sampling rate accuracy verification	45
Balanced input sampling rate accuracy verification	46
Balanced output level accuracy verification	48
Balanced output sampling rate accuracy verification	51
Unbalanced input sampling rate accuracy verification	53
Unbalanced output level accuracy verification	54
Unbalanced output sampling rate accuracy verification	57

The performance verification procedures described in this chapter verify that the digital analyzer and generator of the U8903A is operating within its published specifications.



U8903A Options

U8903A Option 113

The U8903A Option 113 expands the audio analyzer with the AES3, SPDIF, and DSI digital audio interfaces. Refer to the *U8903A Audio Analyzer User's Guide (U8903- 90030)* for more information on the digital audio interfaces specifications.

U8903A Option 114

The U8903A Option 114 expands the audio analyzer with the AES3 and SPDIF digital audio interfaces. Refer to the *U8903A Audio Analyzer User's Guide (U8903- 90030)* for more information on the AES3 and SPDIF interfaces specifications.

U8903A Option 115

The U8903A Option 115 expands the audio analyzer with the DSI digital audio interface. Refer to the *U8903A Audio Analyzer User's Guide (U8903- 90030)* for more information on the DSI specifications.

Performance Verification

DSI master clock output frequency accuracy verification

This test measures the sampling rate accuracy on the DSI (Digital Serial Interface) master clock output of U8903A using Agilent 53132A Frequency Counter to ensure that it is within the published specification.

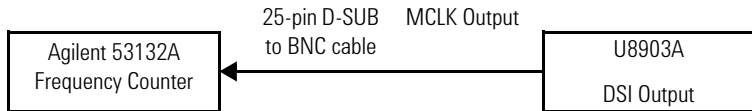

Figure 4-1 Agilent 53132A to DSI MCLK output for DSI master clock output frequency accuracy verification

- 1 Connect Agilent 53132A Frequency Counter input channel 1 to the U8903A DSI MCLK output line using the 25-pin D-SUB to BNC cable (U8903-61305).
- 2 Configure the Agilent 53132A Frequency Counter as follows:
 - Preset the equipment
 - Channel 1 input impedance: 50 Ω
 - Frequency measurement start arming source: Immediate
 - Frequency measurement stop arming source: Timer
 - Frequency arming and measurement gate time: 0.3 s
- 3 Configure the U8903A digital output channel to be tested as follows:
 - DSI output voltage: 3.3 V
 - Reference clock source: Internal
 - DSI audio resolution: 24 bits
 - External reference clock word length: 32
 - External reference clock multiplier: 128

4 Performance Verification for Digital Generator and Analyzer

Performance Verification

- DSI data format: IIS
 - DSI output bit clock sync edge: FALLing
 - DSI Master Clock output state: ON
 - Digital output sampling rate: 48 kHz
 - Digital output function: SINE waveform
 - SINE waveform frequency: 1 kHz
 - SINE waveform amplitude: 1 FFS
 - Digital output state: ON
- 4 Set the DSI audio resolution based on the Word Length as given in “[Test record for DSI master clock output frequency accuracy verification](#)” on page 112.
 - 5 Set the DSI audio word length to 32 bits.
 - 6 Set the Digital Output Sampling Rate based on the sampling rate (Hz) as given in “[Test record for DSI master clock output frequency accuracy verification](#)” on page 112.
 - 7 Set the DSI Master Clock Multiplier based on the Master Clock Multiplier as given in “[Test record for DSI master clock output frequency accuracy verification](#)” on page 112.
 - 8 Measure the Master Clock Rate twice and average the two measurements.
 - 9 Record the average Master Clock Rate, F_{measure} in the “[Test record for DSI master clock output frequency accuracy verification](#)” on page 112.
 - 10 Compute the master clock error using the following equation. MCLK is the master clock rate calculated where $MCLK = MUL \times \text{Sampling Rate (Hz)}$.

$$\Delta F_{\text{error ppm}} = [(F_{\text{measure}} - MCLK) / MCLK] \times 1000000$$

Optical input sampling rate accuracy verification

This test measures the sampling rate accuracy on the digital audio input of the U8903A using the digital audio output from the Audio Precision SYS2722 Audio Analyzer to ensure that it is within the published specification.

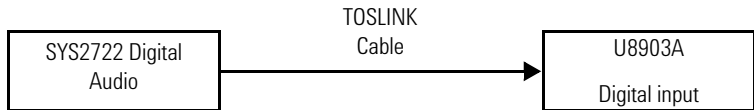

Figure 4-2 SYS2722 Digital Audio to U8903A digital input for optical input sampling rate accuracy verification

- 1 Connect the SYS2722 Audio Analyzer Digital Optical Output channel 1 to the U8903A optical digital input channel using the TOSLINK cable.
- 2 Configure the SYS2722 Audio Analyzer as follows:
 - Digital output connector: Optical
 - Digital output sampling rate: 48 kHz
 - Digital output audio resolution: 24 bits
 - Digital generator output: SINE waveform
 - Channel B amplitude to track channel A
 - SINE waveform frequency: 1 kHz
 - SINE waveform amplitude: 1 FFS
 - Dither type: NONE
 - Digital output: ON
- 3 Configure the U8903A digital input channel to be tested as follows:
 - Digital input type: Optical.
 - Digital measurement sample size: 16384
 - Input coupling for both channel D1 and D2: DC
 - Voltage detector for both channel D1 and D2: RMS
 - AES audio format: LPCM

4 Performance Verification for Digital Generator and Analyzer

Performance Verification

- Channel D1 and D2 FUNCTION1: Frequency
 - Channel D1 and D2 FUNCTION1: AC Voltage
- 4 Set the SYS2722 to output sampling rate as given in “[Test record for optical input sampling rate accuracy verification](#)” on page 132.
 - 5 Set the U8903A digital audio analyzer to measure the sampling rate of the input signal and record the measurement as F_{measure} .
 - 6 Compute the sampling rate error using the following equation. F_{SR} is the sampling rate.
$$\Delta F_{\text{error ppm}} = [(F_{\text{measure}} - F_{\text{SR}}) / F_{\text{SR}}] \times 1000000$$
 - 7 Repeat steps 4 through 6 for the rest of the F_{SR} as given in “[Test record for optical input sampling rate accuracy verification](#)” on page 132 to complete the verification of the different output sampling rates.

Balanced input sampling rate accuracy verification

This test measures the sampling rate accuracy on the digital audio input of U8903A using the digital audio output from Audio Precision SYS2722 Audio Analyzer to ensure that it is within the published specification.

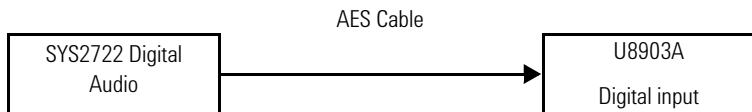

Figure 4-3 SYS2722 Digital Audio to U8903A digital input for balanced input sampling rate accuracy verification

- 1 Connect the SYS2722 Audio Analyzer Digital Balanced Output channel 1 to the U8903A balanced digital input channel using the AES cable.

- 2 Configure the SYS2722 Audio Analyzer as follows:
 - Digital output connector: XLR (Balanced)
 - Digital output sampling rate: 48 kHz
 - Digital output voltage: 4 V_{pp}
 - Digital output audio resolution: 24 bits
 - Digital generator output: SINE waveform
 - Channel B amplitude to track channel A
 - SINE waveform frequency: 1 kHz
 - SINE waveform amplitude: 1 FFS
 - Dither type: NONE
 - Digital output: ON
- 3 Configure the U8903A digital input channel to be tested as follows:
 - Digital input type: Balanced
 - Digital balanced input impedance: 110 Ω
 - Digital measurement sample size: 16384
 - Input coupling for both channel D1 and D2: DC
 - Voltage detector for both channel D1 and D2: RMS
 - AES audio format: LPCM
 - Channel D1 and D2 FUNCTION1: Frequency
 - Channel D1 and D2 FUNCTION1: AC Voltage
- 4 Set the SYS2722 to output sampling rate, F_{SR} as given in [“Test record for balanced input sampling rate accuracy verification”](#) on page 133.
- 5 Set the U8903A digital audio analyzer to measure the sampling rate of the input signal and record the measurement as F_{measure}.
- 6 Compute the sampling rate error using the following equation. F_{SR} is the sampling rate.

$$\Delta F_{error} ppm = [(F_{measure} - F_{SR}) / F_{SR}] \times 1000000$$

4 Performance Verification for Digital Generator and Analyzer

Performance Verification

- Repeat steps 4 through 6 for the rest of the F_{SR} as given in “Test record for balanced input sampling rate accuracy verification” on page 133 to complete the verification of the different output sampling rates.
- Repeat steps 3 through 7 with the digital balanced input impedance set to High impedance (HiZ).

Balanced output level accuracy verification

This test measures the Balanced Output Level accuracy on the digital audio output of U8903A using Agilent DSO8064A Oscilloscope to ensure that it is within the published specification.

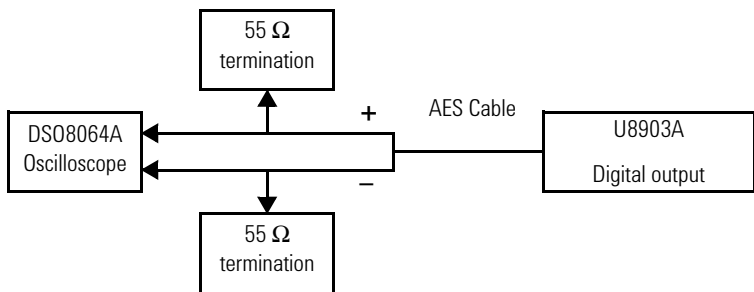

Figure 4-4 DSO8064A oscilloscope to U8903A digital output for balanced output level accuracy verification

- Connect the Agilent DSO8064A Oscilloscope input channel 1 and 2 to the U8903A balanced digital output channel with the 55 Ω termination using the AES cable with separated + and - output lines.
- Configure the DSO8064A oscilloscope as follows:
 - Input channel 1 and 2: Enabled
 - Function 1 to subtract channel 1 and channel 2
 - Function 1: Enabled
 - Function 1 offset: 0

- 3 Configure the U8903A digital output channel to be tested as follows:
 - Digital output type: Balanced
 - Digital output voltage: 2.5 V
 - External reference clock word length: 32
 - External reference clock multiplier: 128
 - Digital output sampling rate: 48 kHz
 - Digital output AES audio resolution: 24 bits
 - Digital output function: SINE waveform
 - SINE waveform frequency: 1 kHz
 - SINE waveform amplitude: 1 FFS
 - Digital output state: ON
- 4 Set the digital output sampling rate to F_{SR} as given in “[Test record for balanced output level accuracy verification](#)” on page 136.
- 5 Set the digital output level to V_{DUT} as given in “[Test record for balanced output level accuracy verification](#)” on page 136.
- 6 Configure the DSO8064A oscilloscope as follows:
 - Time base scale: $1 / (\text{Sampling rate} \times 32 \times 2)$
 - Channel 1 and channel 2 vertical scale and vertical scale range:

Table 4-1 Channel 1 and channel 2 vertical scale and vertical scale range

V_{DUT} (V)	CH1 and CH2 voltage per division (V)	Function 1 vertical scale range (V)
0.3	0.025	0.4
0.5	0.0425	0.68
0.8	0.075	1.2
1	0.085	1.36
1.2	0.1	1.6
1.3	0.125	2

4 Performance Verification for Digital Generator and Analyzer

Performance Verification

Table 4-1 Channel 1 and channel 2 vertical scale and vertical scale range

V_{DUT} (V)	CH1 and CH2 voltage per division (V)	Function 1 vertical scale range (V)
1.5	0.125	2
1.8	0.15	2.4
2.0	0.175	2.8
2.3	0.195	3.12
2.5	0.21	3.36
2.8	0.235	3.76
3	0.25	4
3.3	0.275	4.4
3.5	0.295	4.72
3.8	0.32	5.12
4	0.335	5.36
4.3	0.36	5.76
4.5	0.375	6
4.8	0.4	6.4
5.1	0.425	6.8

- 7** Set the DS8064A oscilloscope to measure the amplitude of Function 1 and record the measurement as $V_{measure}$.
- 8** Compute the level accuracy using the following equation.
 $Level\ Accuracy\ (dB) = 20 \times \text{Log}(V_{amp} / V_{DUT})$
- 9** Repeat steps **6** through **8** for the rest of the V_{DUT} as given in “[Test record for balanced output level accuracy verification](#)” on page 136 to complete the verification of the different voltages.
- 10** Repeat steps **5** through **8** for the rest of the F_{SR} as given in “[Test record for balanced output level accuracy verification](#)” on page 136 to complete the verification of the different sampling rates.

Balanced output sampling rate accuracy verification

This test measures the sampling rate accuracy on the digital audio output of U8903A using Agilent 53132A Frequency Counter to ensure that it is within the published specification.

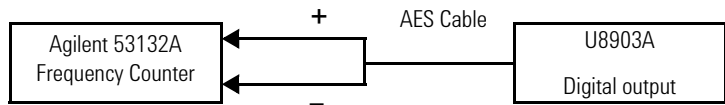

Figure 4-5 Agilent 53132A to U8903A digital output for balanced output sampling rate accuracy verification

- 1 Connect the Agilent 53132A Frequency input channel 1 and 2 to the U8903A balanced digital output channel using the AES cable with separated + and - output lines.
- 2 Configure the Agilent 53132A Frequency Counter as follows:
 - Preset the equipment
 - Channel 1 and channel 2 input impedance: 1 M Ω
 - Frequency measurement start arming source: Immediate
 - Frequency measurement stop arming source: Timer
 - Frequency arming and measurement gate time: 0.5 s
- 3 Configure the U8903A digital output channel to be tested as follows:
 - Reset the U8903A
 - Digital output type: Balanced.
 - Digital output voltage: 4 V
 - External reference clock word length: 32
 - External reference clock multiplier: 128
 - Digital output sampling rate: 48 kHz
 - Digital output AES audio resolution: 24 bits
 - Digital output function: SINE waveform

4 Performance Verification for Digital Generator and Analyzer

Performance Verification

- SINE waveform frequency: 1 kHz
 - SINE waveform amplitude: 1 FFS
 - Digital output state: ON
 - Calibration mode: ON
- 4** Configure U8903A as follows:
- Calibration digital output mode: NORM mode (AES/SPDIF and DSI)
 - Calibration mode: OFF
 - Digital output sampling rate: FSR (refer to “[Test record for balanced output sampling rate accuracy verification](#)” on page 143)
 - Calibration mode: ON
 - Calibration digital output mode: BCOM mode (AES/SPDIF) and NORM mode (DSI)
 - Output signal: Square wave at frequency of $F_{128SR} = 128 \times F_{SR}$
- 5** Set the Frequency Counter to measure the frequency of the output signal on Channel 1 and record the measurement as $F_{measure}$.
- 6** Compute the sampling rate error using the following equation.
- $$\Delta F_{error\ ppm} = (F_{measure} - F_{128SR}) / F_{128SR} \times 1000000$$
- 7** Repeat steps **4** through **6** for the rest of the F_{SR} as given in “[Test record for balanced output sampling rate accuracy verification](#)” on page 143 to complete the verification of the different output sampling rates.
- 8** Set the calibration digital output mode to BCOM mode (AES/SPDIF) and NORM mode (DSI).
- 9** Set the calibration mode to OFF.

Unbalanced input sampling rate accuracy verification

This test measures the sampling rate accuracy on the digital audio input of U8903A using the digital audio output from Audio Precision SYS2722 Audio Analyzer to ensure that it is within the published specification.

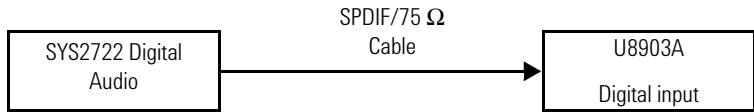

Figure 4-6 SYS2722 Digital Audio to U8903A digital input for unbalanced input sampling rate accuracy verification

- 1 Connect SYS2722 Audio Analyzer Digital Unbalanced Output channel 1 to the U8903A unbalanced digital input channel using the AES3/SPDIF cable.
- 2 Configure the SYS2722 Audio Analyzer as follows:
 - Digital output connector: BNC (Unbalanced)
 - Digital output sampling rate: 48 kHz
 - Digital output voltage: 2.5 Vpp
 - Digital output audio resolution: 24 bits
 - Digital generator output: SINE waveform
 - Enable channel B amplitude to track channel A
 - SINE waveform frequency: 1 kHz
 - SINE waveform amplitude: 1 FFS
 - Dither type: NONE
 - Digital output: ON
- 3 Configure the U8903A digital input channel to be tested as follows:
 - Digital input type: Unbalanced.
 - Digital balanced input impedance: 75 Ω
 - Digital measurement sample size: 16384
 - Input coupling for both channel D1 and D2: DC

4 Performance Verification for Digital Generator and Analyzer

Performance Verification

- Voltage detector for both channel D1 and D2: RMS
 - AES audio format: LPCM
 - Channel D1 and D2 FUNCTION1: Frequency
 - Channel D1 and D2 FUNCTION1: AC Voltage
- 4 Set the SYS2722 to output sampling rate to F_{SR} as given in “[Test record for unbalanced input sampling rate accuracy verification](#)” on page 145.
 - 5 Set the U8903A digital audio analyzer to measure the sampling rate of the input signal and record the measurement as $F_{measure}$.
 - 6 Compute the sampling rate error using the following equation. F_{SR} is the sampling rate.
$$\Delta F_{error\ ppm} = [(F_{measure} - F_{SR}) / F_{SR}] \times 1000000$$
 - 7 Repeat steps 4 through 6 for the rest of the F_{SR} as given in “[Test record for unbalanced input sampling rate accuracy verification](#)” on page 145 to complete the verification of the different output sampling rates.
 - 8 Repeat steps 3 through 7 with the digital balanced input impedance set to High impedance (HiZ).

Unbalanced output level accuracy verification

This test measures the level accuracy on the digital audio output of U8903A using DSO8064A Oscilloscope to ensure that it is within the published specification.

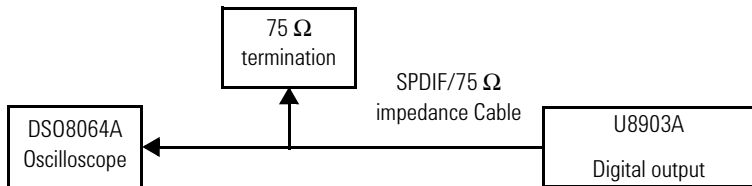

Figure 4-7 DSO8064A oscilloscope to U8903A digital output for unbalanced output level accuracy verification

- 1 Connect Agilent DSO8064A Oscilloscope input channel 1 to the U8903A unbalanced digital output channel with the 75 Ω termination using the SPDIF/75 Ω impedance cable.
- 2 Configure the DSO8064A oscilloscope as follows:
 - Enable input channel
- 3 Configure the U8903A digital output channel to be tested as follows:
 - Digital output type: Unbalanced
 - Digital output voltage: 2.5 V
 - External reference clock word length: 32
 - External reference clock multiplier: 128
 - Digital output sampling rate: 48 kHz
 - Digital output AES audio resolution: 24 bits
 - Digital output function: SINE waveform
 - SINE waveform frequency: 1 kHz
 - SINE waveform amplitude: 1 FFS
 - Digital output state: ON
- 4 Set the digital output sampling rate to F_{SR} as given in “[Test record for unbalanced output level accuracy verification](#)” on page 148.
- 5 Set the digital output level to V_{DUT} as given in “[Test record for unbalanced output level accuracy verification](#)” on page 148.
- 6 Configure the DSO8064A oscilloscope as follows:
 - Timebase scale: 1 / (Sampling rate \times 32 \times 2)
 - Channel 1 vertical scale:

Table 4-2 Channel 1 vertical scale settings

V_{DUT} (V)	Voltage per division (V)
0.3	0.05
0.5	0.085
0.8	0.15

4 Performance Verification for Digital Generator and Analyzer

Performance Verification

Table 4-2 Channel 1 vertical scale settings (continued)

V_{DUT} (V)	Voltage per division (V)
1	0.17
1.2	0.2
1.3	0.25
1.5	0.25
1.8	0.3
2.0	0.35
2.3	0.39
2.5	0.42

- 7** Set the DS8064A oscilloscope to measure the amplitude of Channel 1 and record the measurement as $V_{measure}$.
- 8** Compute the level accuracy using the following equation.
$$Level\ Accuracy\ (dB) = 20 \times \text{Log}(V_{measure} / V_{DUT})$$
- 9** Repeat steps **6** through **8** for the rest of the V_{DUT} as given in “[Test record for unbalanced output level accuracy verification](#)” on page 148 to complete the verification of the different voltages.
- 10** Repeat steps **5** through **8** for the rest of the F_{SR} as given in “[Test record for unbalanced output level accuracy verification](#)” on page 148 to complete the verification of the different sampling rates.

Unbalanced output sampling rate accuracy verification

This test measures the sampling rate accuracy on the digital audio output of U8903A using Audio Precision SYS2722 Audio Analyzer to ensure that it is within the published specification.

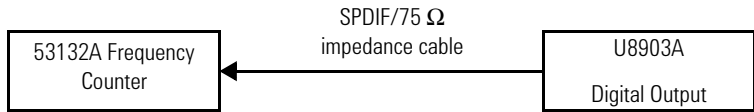

Figure 4-8 Agilent 53132A to U8903A digital output for unbalanced output sampling rate accuracy verification

- 1 Connect 53132A Frequency Counter input channel 1 to the U8903A Unbalanced digital output channel using the SPDIF/75 Ω impedance cable.
- 2 Configure the Agilent 53132A Frequency Counter as follows:
 - Preset the equipment
 - Channel 1 input impedance: 1 M Ω
 - Frequency measurement start arming source: Immediate
 - Frequency measurement stop arming source: Timer
 - Frequency arming and measurement gate time: 0.5 s
- 3 Configure the U8903A digital output channel to be tested as follows:
 - Reset the U8903A
 - Digital output type: Unbalanced
 - Digital output voltage: 2.5 V
 - External reference clock word length: 32
 - External reference clock multiplier: 128
 - Digital output sampling rate: 48 kHz
 - Digital output AES audio resolution: 24 bits
 - Digital output function: SINE waveform

4 Performance Verification for Digital Generator and Analyzer

Performance Verification

- SINE waveform frequency: 1 kHz
 - SINE waveform amplitude: 1 FFS
 - Digital output state: ON
 - Calibration mode: ON
- 4 Configure U8903A as follows:
 - Calibration digital output mode: NORM mode (AES/SPDIF and DSI)
 - Calibration mode: OFF
 - Digital output sampling rate to F_{SR} (refer to “[Test record for unbalanced output sampling rate accuracy verification](#)” on page 154)
 - Calibration mode: ON
 - Calibration digital output mode: BCOM mode (AES/SPDIF) and NORM mode (DSI)
 - Output signal: Square wave at frequency of $F_{128SR} = 128 \times F_{SR}$
 - 5 Set the frequency counter to measure the frequency of the output signal and record the measurement as $F_{measure}$.
 - 6 Compute the sampling rate error using the following equation.
$$\Delta F_{error\ ppm} = (F_{measure} - F_{128SR}) / F_{128SR} \times 1000000$$
 - 7 Repeat steps 4 through 6 for the rest of the F_{SR} as given in “[Test record for unbalanced output sampling rate accuracy verification](#)” on page 154 to complete the verification of the different output sampling rates.
 - 8 Set the calibration digital output mode to BCOM mode (AES/SPDIF) and NORM mode (DSI).
 - 9 Set the calibration mode to OFF.

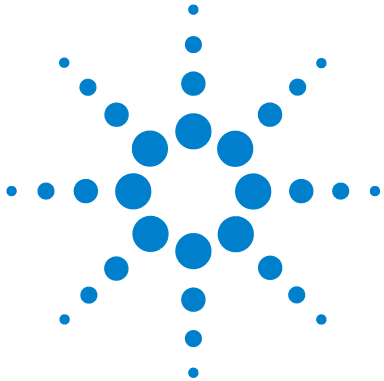

5 U8903A Application Recovery

Overview 60

Application Recovery 61

The procedures described in this chapter guide you to recover the U8903A application software.



Overview

This section contains the procedure to recover the U8903A application software.

The causes for the U8903A application update failure are listed as follows.

- Power failure during application update process
- The external USB flash storage is removed during application update process
- Application update files are corrupted
- Unknown errors

When the U8903A application update fails, the U8903A may not be able to boot up and enter the U8903A GUI.

The tools required before performing the application recovery procedures are listed as follows.

- External USB flash storage
- USB keyboard

Application Recovery

Perform the following procedure to recover the U8903A application software.

- 1 Format the external USB flash storage to a bootable format.

NOTE

If the external USB flash storage is already formatted to a bootable format, proceed to [step 2](#).

- i Download the HP USB Disk Storage Format Tool (Freeware) from the Web sites below.
<http://en.kioskea.net/download/download-127-hp-usb-disk-storage-format-tool> or
<http://files.extremeoverclocking.com/file.php?f=197>.
- ii Install the tool.
- iii After the installation is completed, go to **Start > All Programs > Hewlett-Packard Company > HP USB Disk Storage Format Tool**.
- iv Select the external USB flash storage to be formatted as shown in [Figure 5-1](#).

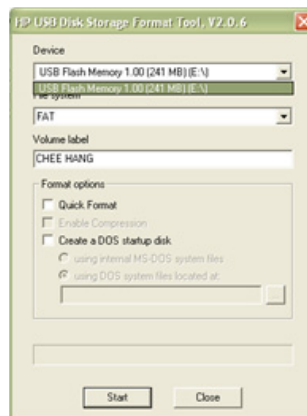

Figure 5-1 Select the external USB flash storage

- v Select the **Create a DOS startup disk** check box and type in C:\New folder\DOSSystemFiles as shown in **Figure 5-2**. Select **Start** to start formatting

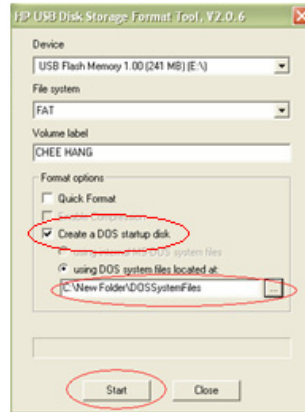

Figure 5-2 Create a DOS startup disk

- 2 After the external USB flash storage is formatted in a bootable format, copy the U8903A application update files into the root directory of the external USB flash storage. An example of the application update files, **NK_R2.3.2.0.jel** and **NK_R2.3.2.0.jel2** are shown in **Figure 5-3**.

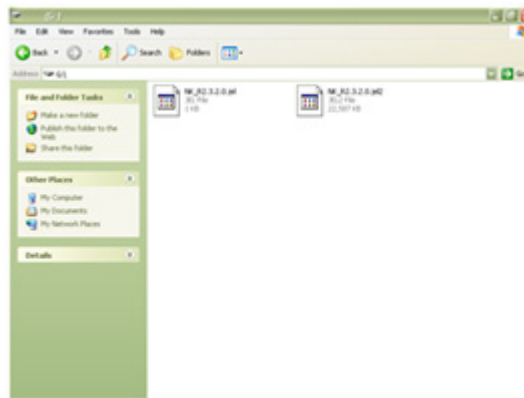

Figure 5-3 Root directory of the external USB flash storage

- 3 Create a copy of the **NK_R2.3.2.0.jel2** file and rename it to **nk.bin**.
- 4 Force the U8903A with the failed application update to shut down by pressing the power button for more than 3 seconds.
- 5 Connect the USB keyboard to the U8903A front panel USB port and turn on the U8903A.
- 6 Hold the **F2** key after the U8903A is turned on to display the System Bios Setup page. Repeat [step 4](#) and [step 5](#) if the System Bios Setup page is not displayed.
- 7 Select **Basic CMOS Configuration** and press **Enter** as shown in [Figure 5-4](#).

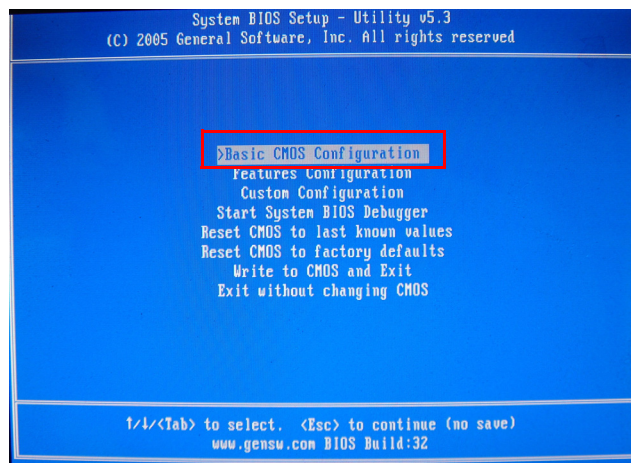

Figure 5-4 System Bios Setup page

- 8 The Basic CMOS Configuration setting is as shown in [Figure 5-5](#).

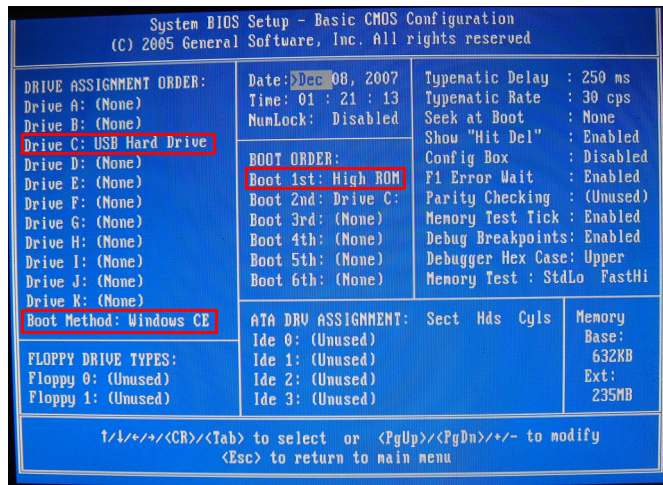

Figure 5-5 Basic CMOS Configuration

- 9 Change the First Boot Order from **High ROM** to **NONE**.
- 10 Press **ESC** to go back to the System Bios Setup page and select **Write to CMOS and Exit**.
- 11 Press **Y** to save the changes and unplug the keyboard from the U8903A front panel USB port and plug in the external USB flash storage.
- 12 The U8903A will boot up using the image stored in the external USB flash storage.
- 13 After the U8903A is booted up successfully, press **System** from the front panel and select **Update > Application > Source > Storage 1**.
- 14 Select the application file to update the U8903A application software.
- 15 A message will pop up to confirm the application update as shown in Figure 5-6. Select **Yes** to continue.

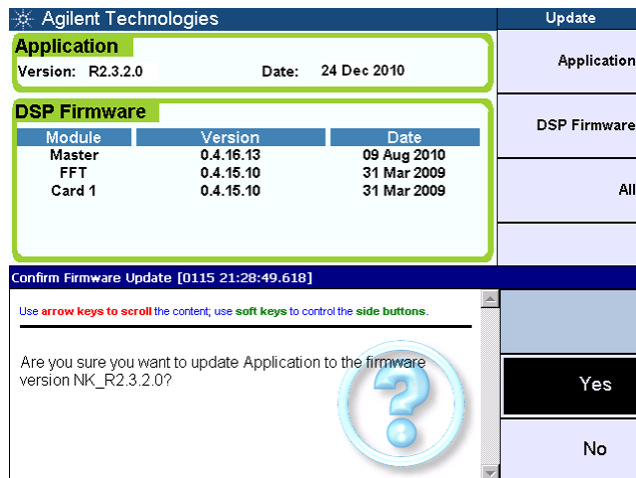

Figure 5-6 Pop up message to confirm application update

- 16** After the U8903A application update is completed, press the power button to turn off the U8903A.
- 17** Remove the external USB flash storage and plug in the USB keyboard.
- 18** Repeat [step 6](#) to [step 11](#) to change the First Boot Order from **NONE** to **High ROM**.

5 U8903A Application Recovery

Application Recovery



6 Theory of Operation

Overview	68
System Block Level Theory	69
Front panel	70
Controller board	70
Power supply	70
LCD display sub-assembly	71
Carrier PCBA	71
Carrier PCBA level theory	72
Digital Audio	75

This chapter describes the operation and functions of each U8903A assembly.



Overview

The U8903A is a digital signal processing (DSP)-based audio measurement system, with a frequency measurement range of 10 Hz to 100 kHz. The U8903A basic configuration consists of two channels of audio generator and analyzer.

The U8903A audio generator has a frequency range of 5 Hz to 80 kHz. Its sine waveform amplitude range is from 0 Vrms to 8 Vrms (11.3 Vp) for the Unbalanced or Common mode test output configuration, and 0 Vrms to 16 Vrms (22.6 Vp) for the Balanced output configuration.

The U8903A audio analyzer has a frequency measurement range of 10 Hz to 100 kHz, as well as an amplitude measurement range of microvolts to 200 Vp (140 Vrms).

Below are the brief features of the U8903A:

- Standalone bench equipment
- 3U rack space (suitable for direct 8903B audio analyzer replacement)
- 24-bit resolution
- AC/DC coupling
- 100 Ω /600 Ω and 50 Ω /600 Ω output impedances for the Balanced and Unbalanced output signals respectively
- 200 k Ω and 100 k Ω input impedances for the Balanced and Unbalanced input signals respectively
- Output frequency range of 5 Hz to 80 kHz
- Frequency measurement range of 10 Hz to 100 kHz
- Square-wave output for amplifier dynamic power test

System Block Level Theory

The block diagram of the U8903A system is shown in Figure 6-1.

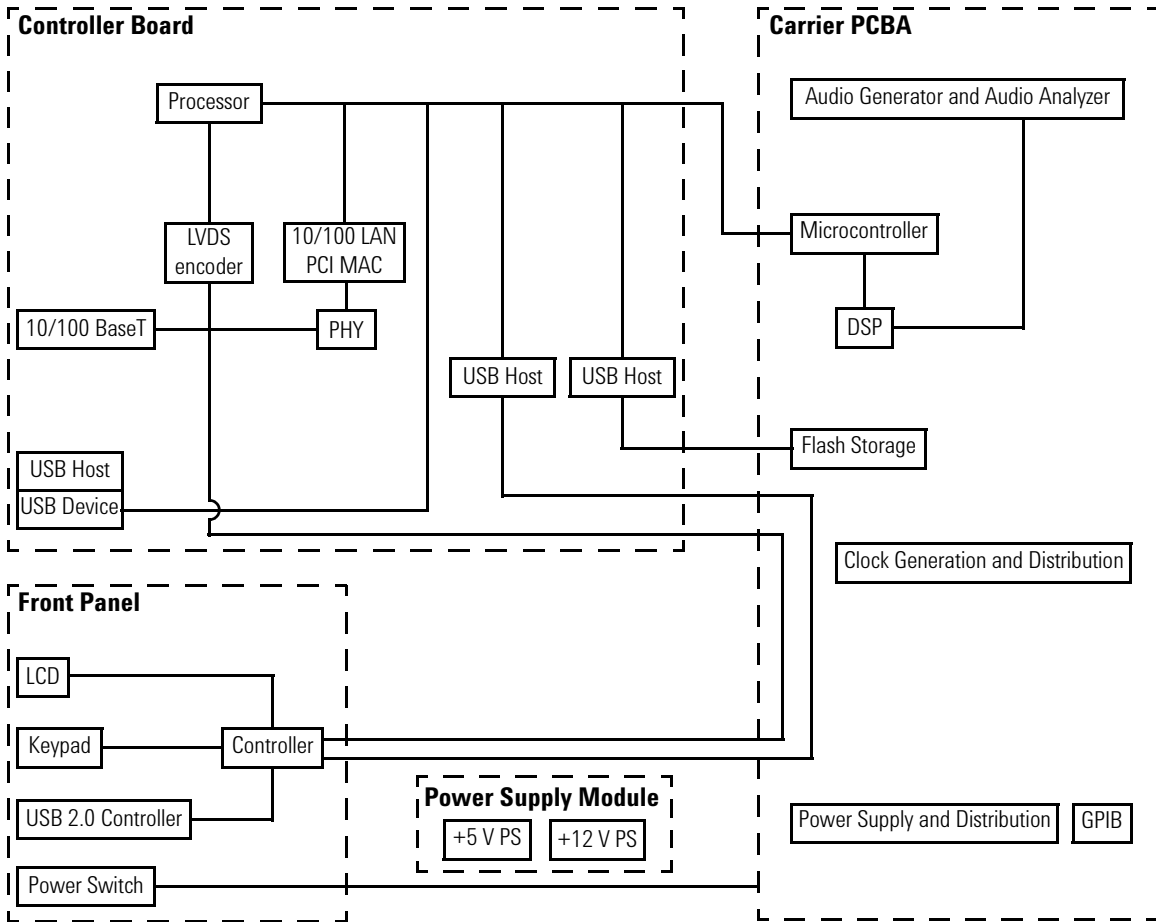

Figure 6-1 U8903A system block diagram

Front panel

The front panel provides a dedicated knob and keypad for major control functions in the U8903A together with a 15-inch panel display. The U8903A also provides XLR and BNC connectors for audio generator and analyzer connections. The front panel is controlled by the microcontroller, which is located on the front panel board. The display controller is located on the controller board.

A USB 2.0 port and a headphone jack (Reserved for future expansion) are available on the front panel.

There are 47 dedicated keys on the front panel. A conductive element under each key will short a gap on the keyboard circuit. The field-programmable gate array (FPGA) detects which key has been pressed and sends the appropriate command to the processor. The knob on the front panel controls a mechanical encoder. The output of the encoder is read by the FPGA for the direction and distance turned for each setting from the knob.

Controller board

The controller board provides features such as the CPU, DDR memory controller, graphic processor, display controller, and rear panel I/O controller. The rear panel I/O controller consists of features such as the USB host control, LAN, and VGA (external display). The controller board requires a DC supply of 5 V, +3.3 V, +3.3 V AUX, and +3.3 V battery (BIOS).

Power supply

The AC input power to the U8903A is 100 Vac to 240 Vac, 47 Hz to 63 Hz. The maximum output power is 250 W.

The main DC voltages in the U8903A are of +3.3 V, +5 V, +12 V, and -12 V.

LCD display sub-assembly

The display is a thin film liquid-crystal display (TFT-LCD). It measures 15 inches diagonally and consists of a 640 × 480 pixel VGA color monitor. This assembly requires +3.3 Vdc and +12 Vdc from the power supply.

A twin fluorescent backlight provides illumination for the LCD. The backlight inverter board assembly converts the +12 Vdc to 1800 Vac to drive the backlight.

Carrier PCBA

The carrier PCBA is the main board for the audio generator, audio analyzer, clock control, and trigger control. It also acts as an interface board for other boards in the U8903A such as controller, front panel, flash storage, and power supply.

For more details on the carrier PCBA, refer to [“Carrier PCBA level theory”](#) on page 72.

Carrier PCBA level theory

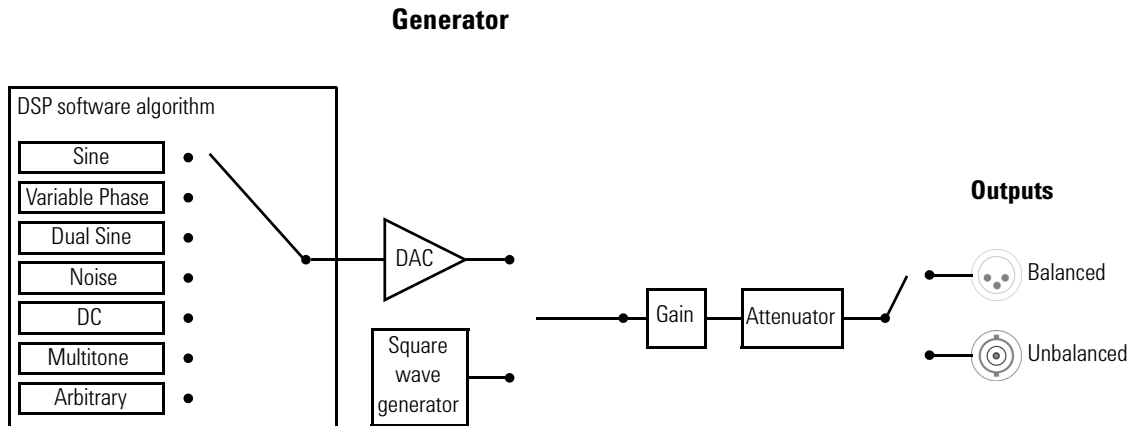

Figure 6-2 Simplified block diagram for generator

The generator features are listed as follows.

- Balanced output signals (XLR)
- Unbalanced output signals (BNC)
- Common mode test output signals (XLR)
- Selectable output impedance (100 Ω /600 Ω and 50 Ω /600 Ω for the Balanced and Unbalanced output signals respectively)
- Sine waveform
- Square waveform
- Variable phase waveform
- Noise signal
- DC signal
- Dual sine waveforms which include SMPTE intermodulation distortion (SMPTE IMD) and difference frequency distortion (DFD) waveform types
- Multitone generation
- User-defined arbitrary waveform

Analyzer

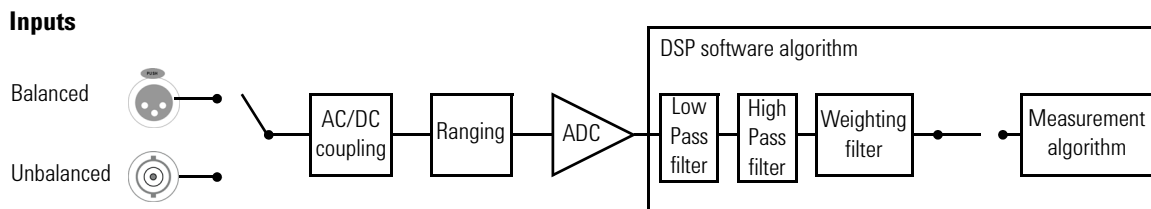

Figure 6-3 Simplified block diagram for analyzer

Below is the list of the audio analyzer features.

- Balanced input signals (XLR)
- Unbalanced input signals (BNC)
- Frequency measurement
- AC voltage measurement
- DC voltage measurement
- Phase measurement
- THD+N Ratio measurement
- THD+N Level measurement
- SINAD measurement
- Signal-to-noise ratio (SNR) measurement
- Noise Level measurement
- SMPTE IMD measurement
- DFD measurement
- Crosstalk measurement
- RMS, Peak-to-Peak, Quasi Peak type detectors
- AC/DC coupling
- Digital filters such as low pass, high pass, and weighting filters
- Input autoranging
- Selectable measurement bandwidth
- Selectable measurement time
- Free Run or External trigger mode

Clock

The U8903A uses a 40 MHz clock with 1 ppm to achieve high frequency accuracy. The drift of the clock is less than 0.1 ppm/° C, thus ensuring a very low drift of the clock accuracy with the change of temperature. Low phase noise in the clock is necessary to ensure good noise performance for the analog-to-digital converter (ADC). All the clocks for the digital signal processor (DSP) and data converters are derived from the same clock source to achieve clock synchronization. A positive emitter-coupled logic (PECL) buffer is used to distribute the clock to all devices with a negative emitter-coupled logic (NECL) receiver.

GPIB control

The GPIB port is used for controlling instruments.

Flash storage

The carrier PCBA contains a flash storage slot with a default capacity of 4 GB.

Digital Audio

The block diagrams of the U8903A digital audio interface are shown in Figure 6-4 and Figure 6-5.

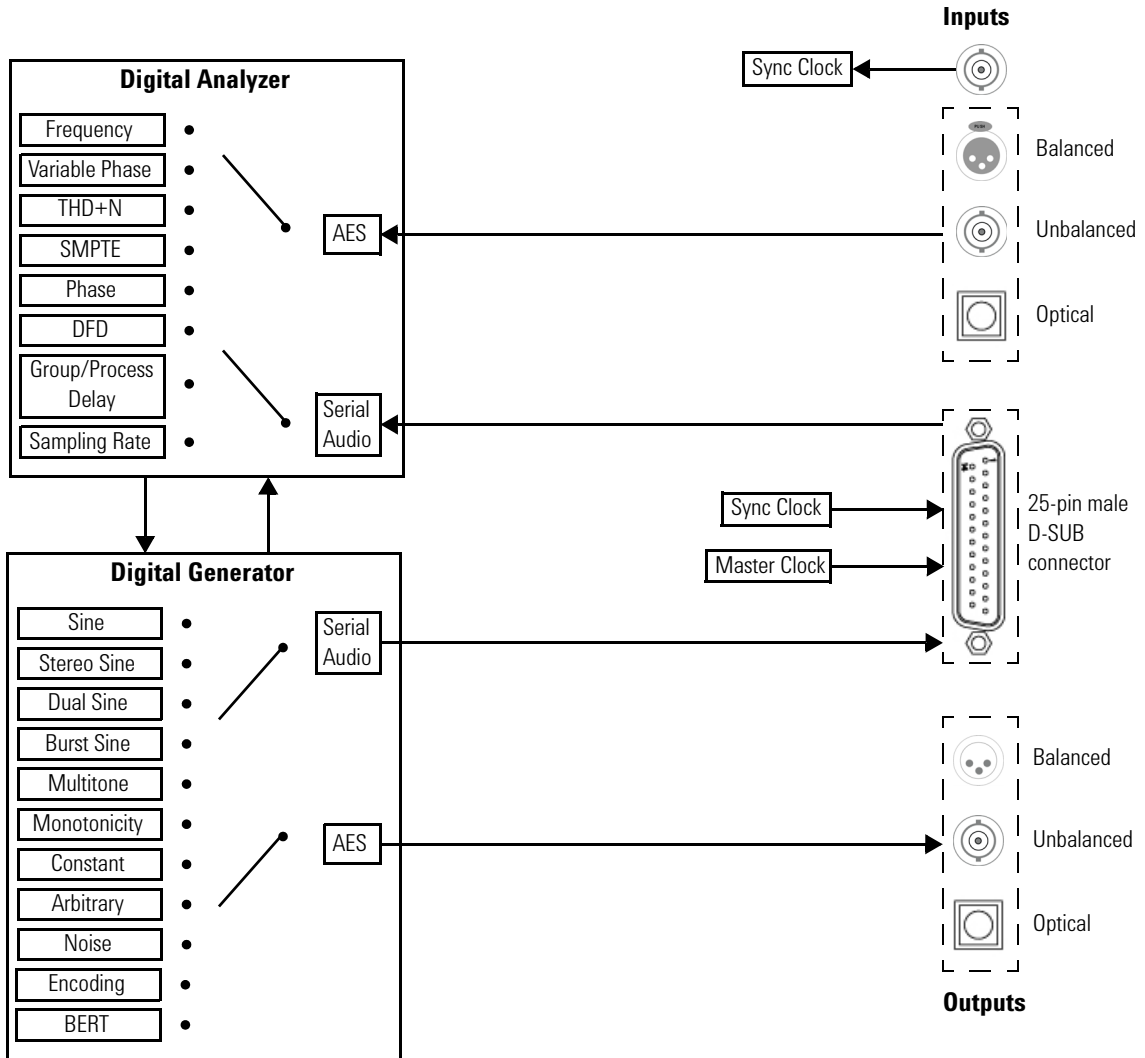

Figure 6-4 Digital audio interface block diagram

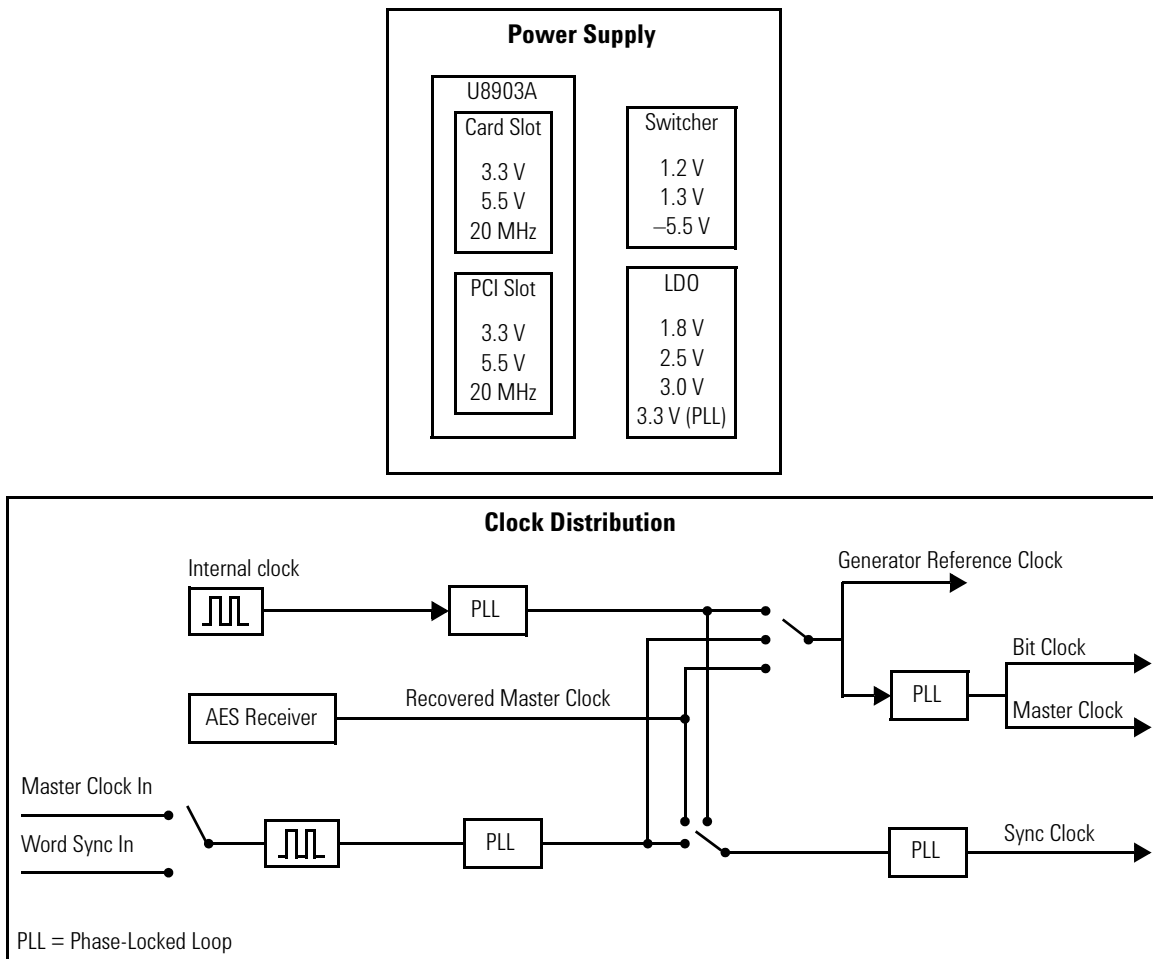

Figure 6-5 Digital audio interface power supply and clock distribution

The U8903A digital audio card is developed to enhanced the U8903A with digital audio interface capability. It uses the PCI slot in the U8903A and provides AES3/SPDIF digital audio signal interface capabilities. In addition, it also provides the DSI capability for direct connectivity to inter-IC audio.

The U8903A digital audio card is capable of providing three different types of digital audio interface.

- AES3
- SPDIF
- DSI (Left justified, right justified, I²C, DSP format)

The U8903A digital audio card is also capable of providing two additional DC voltage outputs with 200 mA each via the 25-pin male D-SUB connector.

- 3.3 V
- 5.0 V

6 Theory of Operation

Digital Audio



Appendix A

Analog Generator Performance Verification	80
Test record for DC accuracy verification	80
Test record for AC accuracy verification	83
Test record for flatness verification	84
Test record for frequency accuracy verification	86
Test record for crosstalk verification	86
Test record for distortion verification	87
Test record for square wave rise time verification	87
Test record for square wave amplitude accuracy verification	88
Analog Analyzer Performance Verification	89
Test record for DC accuracy verification	89
Test record for AC accuracy verification	90
Test record for flatness verification	91
Test record for frequency accuracy verification	108
Test record for phase accuracy verification	108
Test record for crosstalk verification	109
Test record for distortion verification	109
Test record for residual IMD verification	109
Test record for CMRR verification	110



Analog Generator Performance Verification

Test record for DC accuracy verification

V_{DUT} (V)	V_{DMM} (V) (Channel 1)	V_{DMM} (V) (Channel 2)	DC accuracy (%) (Channel 1)	DC accuracy (%) (Channel 2)
-10.00				
-9.75				
-9.50				
-9.25				
-9.00				
-8.75				
-8.50				
-8.25				
-8.00				
-7.75				
-7.50				
-7.25				
-7.00				
-6.75				
-6.50				
-6.25				
-6.00				
-5.75				
-5.50				
-5.25				

V_{DUT} (V)	V_{DMM} (V) (Channel 1)	V_{DMM} (V) (Channel 2)	DC accuracy (%) (Channel 1)	DC accuracy (%) (Channel 2)
-5.00				
-4.75				
-4.50				
-4.25				
-4.00				
-3.75				
-3.50				
-3.25				
-3.00				
-2.75				
-2.50				
-2.25				
-2.00				
-1.75				
-1.50				
-1.25				
-1.00				
-0.75				
-0.50				
-0.25				
0.25				
0.50				
0.75				
1.00				
1.25				

A Appendix A

Analog Generator Performance Verification

V_{DUT} (V)	V_{DMM} (V) (Channel 1)	V_{DMM} (V) (Channel 2)	DC accuracy (%) (Channel 1)	DC accuracy (%) (Channel 2)
1.50				
1.75				
2.00				
2.25				
2.50				
2.75				
3.00				
3.25				
3.50				
3.75				
4.00				
4.25				
4.50				
4.75				
5.00				
5.25				
5.50				
5.75				
6.00				
6.25				
6.50				
6.75				
7.00				
7.25				
7.50				

V_{DUT} (V)	V_{DMM} (V) (Channel 1)	V_{DMM} (V) (Channel 2)	DC accuracy (%) (Channel 1)	DC accuracy (%) (Channel 2)
7.75				
8.00				
8.25				
8.50				
8.75				
9.00				
9.25				
9.50				
9.75				
10.00				

Test record for AC accuracy verification

V_{DUT} (Vrms)	f_{DUT} (Hz)	V_{DMM} (Vrms) (Channel 1)	V_{DMM} (Vrms) (Channel 2)	AC accuracy (%) (Channel 1)	AC accuracy (%) (Channel 2)
0.005	1000				
0.05	1000				
0.08	1000				
0.10	1000				
0.13	1000				
0.15	1000				
0.18	1000				
0.25	1000				
0.35	1000				
0.40	1000				

A Appendix A

Analog Generator Performance Verification

V_{DUT} (Vrms)	f_{DUT} (Hz)	V_{DMM} (Vrms) (Channel 1)	V_{DMM} (Vrms) (Channel 2)	AC accuracy (%) (Channel 1)	AC accuracy (%) (Channel 2)
0.50	1000				
0.70	1000				
0.80	1000				
1.00	1000				
1.10	1000				
1.50	1000				
2.00	1000				
2.50	1000				
3.00	1000				
4.00	1000				
5.00	1000				
6.00	1000				
7.00	1000				

Test record for flatness verification

V_{DUT} (Vrms)	f_{DUT} (Hz)	V_{DMM} (Vrms) (Channel 1)	V_{DMM} (Vrms) (Channel 2)	Flatness (dB) (Channel 1)	Flatness (dB) (Channel 2)
0.1	5				
0.1	20				
0.1	250				
0.1	1000				
0.1	16250				
0.1	25000				
0.1	35000				

V_{DUT} (Vrms)	f_{DUT} (Hz)	V_{DMM} (Vrms) (Channel 1)	V_{DMM} (Vrms) (Channel 2)	Flatness (dB) (Channel 1)	Flatness (dB) (Channel 2)
0.1	45000				
0.1	55000				
0.1	65000				
0.1	75000				
0.1	80000				
7.0	5				
7.0	20				
7.0	250				
7.0	1000				
7.0	16250				
7.0	25000				
7.0	35000				
7.0	45000				
7.0	55000				
7.0	65000				
7.0	75000				
7.0	80000				

A Appendix A

Analog Generator Performance Verification

Test record for frequency accuracy verification

f_{DUT} (Hz)	f_{FC} (Hz) (Channel 1)	f_{FC} (Hz) (Channel 2)	Frequency accuracy (ppm) (Channel 1)	Frequency accuracy (ppm) (Channel 2)
50				
100				
200				
500				
1000				
2000				
5000				
10000				
20000				
50000				
80000				

Test record for crosstalk verification

V_{DUT} (Vrms)	f_{DUT} (Hz)	V_{meas} (dBV)	Crosstalk (dB) (Channel 1 to Channel 2)	Crosstalk (dB) (Channel 2 to Channel 1)
0.15	180			
0.15	1000			
0.15	20000			
0.15	50000			
0.15	80000			

Test record for distortion verification

Distortion (dB) (Channel 1)	Distortion (dB) (Channel 2)

Test record for square wave rise time verification

V_{DUT} (Vrms)	t_{rise} (s) (Channel 1)	t_{rise} (s) (Channel 2)
0.005		
1.2		
10		

A Appendix A

Analog Generator Performance Verification

Test record for square wave amplitude accuracy verification

V_{DUT} (Vrms)	f_{DUT} (Hz)	V_{DMM} (Vrms) (Channel 1)	V_{DMM} (Vrms) (Channel 2)	Amplitude accuracy (%) (Channel 1)	Amplitude accuracy (%) (Channel 2)
0.005	1000				
0.06	1000				
0.12	1000				
0.15	1000				
0.19	1000				
0.22	1000				
0.25	1000				
0.35	1000				
0.47	1000				
0.6	1000				
0.75	1000				
0.9	1000				
1.2	1000				
1.4	1000				
1.6	1000				
2.2	1000				
3	1000				
3.8	1000				
4.7	1000				
6	1000				
7.5	1000				
8.7	1000				
10	1000				

Analog Analyzer Performance Verification

Test record for DC accuracy verification

V_{IN} (V)	V_{DUT} (V) (Channel 1)	V_{DUT} (V) (Channel 2)	DC accuracy (%) (Channel 1)	DC accuracy (%) (Channel 2)
-140.0				
-100.0				
-50.0				
-25.0				
-12.8				
-6.4				
-3.2				
-1.6				
-0.8				
-0.4				
0.4				
0.8				
1.6				
3.2				
6.4				
12.8				
25.0				
50.0				
100.0				
140.0				

Test record for AC accuracy verification

Low measurement bandwidth

V_{IN} (Vrms)	f_{IN} (Hz)	V_{DUT} (Vrms) (Channel 1)	V_{DUT} (Vrms) (Channel 2)	AC accuracy (%) (Channel 1)	AC accuracy (%) (Channel 2)
0.2	1000				
0.6	1000				
1	1000				
2.4	1000				
4.8	1000				
9.6	1000				
19.2	1000				
38.4	1000				
76.7	1000				
120	1000				

High measurement bandwidth

V_{IN} (Vrms)	f_{IN} (Hz)	V_{DUT} (Vrms) (Channel 1)	V_{DUT} (Vrms) (Channel 2)	AC accuracy (%) (Channel 1)	AC accuracy (%) (Channel 2)
0.2	1000				
0.6	1000				
1	1000				
2.4	1000				
4.8	1000				
9.6	1000				
19.2	1000				
38.4	1000				

V_{IN} (Vrms)	f_{IN} (Hz)	V_{DUT} (Vrms) (Channel 1)	V_{DUT} (Vrms) (Channel 2)	AC accuracy (%) (Channel 1)	AC accuracy (%) (Channel 2)
76.7	1000				
120	1000				

Test record for flatness verification

Low measurement bandwidth

V_{IN} (Vrms)	f_{IN} (Hz)	V_{DUT} (Vrms) (Channel 1)	V_{DUT} (Vrms) (Channel 2)	Flatness (dB) (Channel 1)	Flatness (dB) (Channel 2)
0.2	20				
0.2	500				
0.2	1050				
0.2	1850				
0.2	2650				
0.2	3450				
0.2	4250				
0.2	5050				
0.2	5850				
0.2	6650				
0.2	7450				
0.2	8250				
0.2	9050				
0.2	9850				
0.2	10650				
0.2	11450				
0.2	12250				

A Appendix A

Analog Analyzer Performance Verification

V_{IN} (Vrms)	f_{IN} (Hz)	V_{DUT} (Vrms) (Channel 1)	V_{DUT} (Vrms) (Channel 2)	Flatness (dB) (Channel 1)	Flatness (dB) (Channel 2)
0.2	13050				
0.2	13850				
0.2	14650				
0.2	15450				
0.2	16250				
0.2	17050				
0.2	17850				
0.2	18650				
0.2	19450				
0.2	20250				
0.2	21050				
0.2	21850				
0.2	22650				
0.2	23450				
0.2	24250				
0.2	25050				
0.2	25850				
0.2	26650				
0.2	27450				
0.2	28250				
0.2	29050				
0.2	29850				
0.2	30000				
0.6	20				
0.6	500				

V_{IN} (Vrms)	f_{IN} (Hz)	V_{DUT} (Vrms) (Channel 1)	V_{DUT} (Vrms) (Channel 2)	Flatness (dB) (Channel 1)	Flatness (dB) (Channel 2)
0.6	1050				
0.6	1850				
0.6	2650				
0.6	3450				
0.6	4250				
0.6	5050				
0.6	5850				
0.6	6650				
0.6	7450				
0.6	8250				
0.6	9050				
0.6	9850				
0.6	10650				
0.6	11450				
0.6	12250				
0.6	13050				
0.6	13850				
0.6	14650				
0.6	15450				
0.6	16250				
0.6	17050				
0.6	17850				
0.6	18650				
0.6	19450				
0.6	20250				

A Appendix A

Analog Analyzer Performance Verification

V_{IN} (Vrms)	f_{IN} (Hz)	V_{DUT} (Vrms) (Channel 1)	V_{DUT} (Vrms) (Channel 2)	Flatness (dB) (Channel 1)	Flatness (dB) (Channel 2)
0.6	21050				
0.6	21850				
0.6	22650				
0.6	23450				
0.6	24250				
0.6	25050				
0.6	25850				
0.6	26650				
0.6	27450				
0.6	28250				
0.6	29050				
0.6	29850				
0.6	30000				
9.6	20				
9.6	500				
9.6	1050				
9.6	1850				
9.6	2650				
9.6	3450				
9.6	4250				
9.6	5050				
9.6	5850				
9.6	6650				
9.6	7450				
9.6	8250				

V_{IN} (Vrms)	f_{IN} (Hz)	V_{DUT} (Vrms) (Channel 1)	V_{DUT} (Vrms) (Channel 2)	Flatness (dB) (Channel 1)	Flatness (dB) (Channel 2)
9.6	9050				
9.6	9850				
9.6	10650				
9.6	11450				
9.6	12250				
9.6	13050				
9.6	13850				
9.6	14650				
9.6	15450				
9.6	16250				
9.6	17050				
9.6	17850				
9.6	18650				
9.6	19450				
9.6	20250				
9.6	21050				
9.6	21850				
9.6	22650				
9.6	23450				
9.6	24250				
9.6	25050				
9.6	25850				
9.6	26650				
9.6	27450				
9.6	28250				

A Appendix A

Analog Analyzer Performance Verification

V_{IN} (Vrms)	f_{IN} (Hz)	V_{DUT} (Vrms) (Channel 1)	V_{DUT} (Vrms) (Channel 2)	Flatness (dB) (Channel 1)	Flatness (dB) (Channel 2)
9.6	29050				
9.6	29850				
9.6	30000				
38.4	20				
38.4	500				
38.4	1050				
38.4	1850				
38.4	2650				
38.4	3450				
38.4	4250				
38.4	5050				
38.4	5850				
38.4	6650				
38.4	7450				
38.4	8250				
38.4	9050				
38.4	9850				
38.4	10650				
38.4	11450				
38.4	12250				
38.4	13050				
38.4	13850				
38.4	14650				
38.4	15450				
38.4	16250				

V_{IN} (Vrms)	f_{IN} (Hz)	V_{DUT} (Vrms) (Channel 1)	V_{DUT} (Vrms) (Channel 2)	Flatness (dB) (Channel 1)	Flatness (dB) (Channel 2)
38.4	17050				
38.4	17850				
38.4	18650				
38.4	19450				
38.4	20250				
38.4	21050				
38.4	21850				
38.4	22650				
38.4	23450				
38.4	24250				
38.4	25050				
38.4	25850				
38.4	26650				
38.4	27450				
38.4	28250				
38.4	29050				
38.4	29850				
38.4	30000				
76.7	20				
76.7	500				
76.7	1050				
76.7	1850				
76.7	2650				
76.7	3450				
76.7	4250				

A Appendix A

Analog Analyzer Performance Verification

V_{IN} (Vrms)	f_{IN} (Hz)	V_{DUT} (Vrms) (Channel 1)	V_{DUT} (Vrms) (Channel 2)	Flatness (dB) (Channel 1)	Flatness (dB) (Channel 2)
76.7	5050				
76.7	5850				
76.7	6650				
76.7	7450				
76.7	8250				
76.7	9050				
76.7	9850				
76.7	10650				
76.7	11450				
76.7	12250				
76.7	13050				
76.7	13850				
76.7	14650				
76.7	15450				
76.7	16250				
76.7	17050				
76.7	17850				
76.7	18650				
76.7	19450				
76.7	20250				
76.7	21050				
76.7	21850				
76.7	22650				
76.7	23450				
76.7	24250				

V_{IN} (Vrms)	f_{IN} (Hz)	V_{DUT} (Vrms) (Channel 1)	V_{DUT} (Vrms) (Channel 2)	Flatness (dB) (Channel 1)	Flatness (dB) (Channel 2)
76.7	25050				
76.7	25850				
76.7	26650				
76.7	27450				
76.7	28250				
76.7	29050				
76.7	29850				
76.7	30000				

High measurement bandwidth

V_{IN} (Vrms)	f_{IN} (Hz)	V_{DUT} (Vrms) (Channel 1)	V_{DUT} (Vrms) (Channel 2)	Flatness (dB) (Channel 1)	Flatness (dB) (Channel 2)
0.2	20				
0.2	2500				
0.2	5000				
0.2	7500				
0.2	10000				
0.2	12500				
0.2	15000				
0.2	17500				
0.2	20000				
0.2	22500				
0.2	25000				
0.2	27500				
0.2	30000				
0.2	32500				

A Appendix A

Analog Analyzer Performance Verification

V_{IN} (Vrms)	f_{IN} (Hz)	V_{DUT} (Vrms) (Channel 1)	V_{DUT} (Vrms) (Channel 2)	Flatness (dB) (Channel 1)	Flatness (dB) (Channel 2)
0.2	35000				
0.2	37500				
0.2	40000				
0.2	42500				
0.2	45000				
0.2	47500				
0.2	50000				
0.2	52500				
0.2	55000				
0.2	57500				
0.2	60000				
0.2	62500				
0.2	65000				
0.2	67500				
0.2	70000				
0.2	72500				
0.2	75000				
0.2	77500				
0.2	80000				
0.2	82500				
0.2	85000				
0.2	87500				
0.2	90000				
0.2	92500				
0.2	95000				

V_{IN} (Vrms)	f_{IN} (Hz)	V_{DUT} (Vrms) (Channel 1)	V_{DUT} (Vrms) (Channel 2)	Flatness (dB) (Channel 1)	Flatness (dB) (Channel 2)
0.2	97500				
0.2	100000				
0.6	20				
0.6	2500				
0.6	5000				
0.6	7500				
0.6	10000				
0.6	12500				
0.6	15000				
0.6	17500				
0.6	20000				
0.6	22500				
0.6	25000				
0.6	27500				
0.6	30000				
0.6	32500				
0.6	35000				
0.6	37500				
0.6	40000				
0.6	42500				
0.6	45000				
0.6	47500				
0.6	50000				
0.6	52500				
0.6	55000				

A Appendix A

Analog Analyzer Performance Verification

V_{IN} (Vrms)	f_{IN} (Hz)	V_{DUT} (Vrms) (Channel 1)	V_{DUT} (Vrms) (Channel 2)	Flatness (dB) (Channel 1)	Flatness (dB) (Channel 2)
0.6	57500				
0.6	60000				
0.6	62500				
0.6	65000				
0.6	67500				
0.6	70000				
0.6	72500				
0.6	75000				
0.6	77500				
0.6	80000				
0.6	82500				
0.6	85000				
0.6	87500				
0.6	90000				
0.6	92500				
0.6	95000				
0.6	97500				
0.6	100000				
9.6	20				
9.6	2500				
9.6	5000				
9.6	7500				
9.6	10000				
9.6	12500				
9.6	15000				

V_{IN} (Vrms)	f_{IN} (Hz)	V_{DUT} (Vrms) (Channel 1)	V_{DUT} (Vrms) (Channel 2)	Flatness (dB) (Channel 1)	Flatness (dB) (Channel 2)
9.6	17500				
9.6	20000				
9.6	22500				
9.6	25000				
9.6	27500				
9.6	30000				
9.6	32500				
9.6	35000				
9.6	37500				
9.6	40000				
9.6	42500				
9.6	45000				
9.6	47500				
9.6	50000				
9.6	52500				
9.6	55000				
9.6	57500				
9.6	60000				
9.6	62500				
9.6	65000				
9.6	67500				
9.6	70000				
9.6	72500				
9.6	75000				
9.6	77500				

A Appendix A

Analog Analyzer Performance Verification

V_{IN} (Vrms)	f_{IN} (Hz)	V_{DUT} (Vrms) (Channel 1)	V_{DUT} (Vrms) (Channel 2)	Flatness (dB) (Channel 1)	Flatness (dB) (Channel 2)
9.6	80000				
9.6	82500				
9.6	85000				
9.6	87500				
9.6	90000				
9.6	92500				
9.6	95000				
9.6	97500				
9.6	100000				
38.4	20				
38.4	2500				
38.4	5000				
38.4	7500				
38.4	10000				
38.4	12500				
38.4	15000				
38.4	17500				
38.4	20000				
38.4	22500				
38.4	25000				
38.4	27500				
38.4	30000				
38.4	32500				
38.4	35000				
38.4	37500				

V_{IN} (Vrms)	f_{IN} (Hz)	V_{DUT} (Vrms) (Channel 1)	V_{DUT} (Vrms) (Channel 2)	Flatness (dB) (Channel 1)	Flatness (dB) (Channel 2)
38.4	40000				
38.4	42500				
38.4	45000				
38.4	47500				
38.4	50000				
38.4	52500				
38.4	55000				
38.4	57500				
38.4	60000				
38.4	62500				
38.4	65000				
38.4	67500				
38.4	70000				
38.4	72500				
38.4	75000				
38.4	77500				
38.4	80000				
38.4	82500				
38.4	85000				
38.4	87500				
38.4	90000				
38.4	92500				
38.4	95000				
38.4	97500				
38.4	100000				

A Appendix A

Analog Analyzer Performance Verification

V_{IN} (Vrms)	f_{IN} (Hz)	V_{DUT} (Vrms) (Channel 1)	V_{DUT} (Vrms) (Channel 2)	Flatness (dB) (Channel 1)	Flatness (dB) (Channel 2)
76.7	20				
76.7	2500				
76.7	5000				
76.7	7500				
76.7	10000				
76.7	12500				
76.7	15000				
76.7	17500				
76.7	20000				
76.7	22500				
76.7	25000				
76.7	27500				
76.7	30000				
76.7	32500				
76.7	35000				
76.7	37500				
76.7	40000				
76.7	42500				
76.7	45000				
76.7	47500				
76.7	50000				
76.7	52500				
76.7	55000				
76.7	57500				
76.7	60000				

V_{IN} (Vrms)	f_{IN} (Hz)	V_{DUT} (Vrms) (Channel 1)	V_{DUT} (Vrms) (Channel 2)	Flatness (dB) (Channel 1)	Flatness (dB) (Channel 2)
76.7	62500				
76.7	65000				
76.7	67500				
76.7	70000				
76.7	72500				
76.7	75000				
76.7	77500				
76.7	80000				
76.7	82500				
76.7	85000				
76.7	87500				
76.7	90000				
76.7	92500				
76.7	95000				
76.7	97500				
76.7	100000				

A Appendix A

Analog Analyzer Performance Verification

Test record for frequency accuracy verification

f_{IN} (Hz)	f_{FC} (Hz) (Channel 1)	f_{DUT} (Hz) (Channel 1)	f_{error} (Hz) (Channel 1)	f_{FC} (Hz) (Channel 2)	f_{DUT} (Hz) (Channel 2)	f_{error} (Hz) (Channel 2)	Frequency accuracy (ppm) (Channel 1)	Frequency accuracy (ppm) (Channel 2)
50								
100								
200								
500								
1000								
2000								
5000								
10000								
20000								
50000								
80000								

Test record for phase accuracy verification

f_{IN} (Hz)	Phase accuracy ($^{\circ}$)
1000	
2000	
5000	
10000	
20000	
50000	

Test record for crosstalk verification

f_{IN} (Hz)	Crosstalk (dB) (Channel 1 to Channel 2)	Crosstalk (dB) (Channel 2 to Channel 1)
100		
1000		
20000		

Test record for distortion verification

Distortion (dB) (Channel 1)	Distortion (dB) (Channel 2)

Test record for residual IMD verification

Profile	Tone 1 frequency (Hz)	Tone 2 frequency (Hz)	Amplitude (Vrms)	Dual amplitude ratio (%)	Residual IMD (dB) (Channel 1)		Residual IMD (dB) (Channel 2)	
					UNB	BAL	UNB	BAL
1	60	7000	2.00	100				
2	170	7000	2.00	100				
3	300	7000	2.00	100				

A Appendix A

Analog Analyzer Performance Verification

Test record for CMRR verification

f_{IN} (Hz)	R_{IN} (V)	V_{DUT} dBV (Channel 1)	V_{DUT} dBV (Channel 2)	CMRR (dB) (Channel 1)	CMRR (dB) (Channel 2)
500	6.4				
1000	6.4				
10000	6.4				
20000	6.4				
500	140				
1000	140				
10000	140				
20000	140				



Appendix B

Digital Generator and Analyzer Performance Verification	112
Test record for DSI master clock output frequency accuracy verification	112
Test record for optical input sampling rate accuracy verification	132
Test record for balanced input sampling rate accuracy verification	133
Test record for balanced output level accuracy verification	136
Test record for balanced output sampling rate accuracy verification	143
Test record for unbalanced input sampling rate accuracy verification	145
Test record for unbalanced output level accuracy verification	148
Test record for unbalanced output sampling rate accuracy verification	154



Digital Generator and Analyzer Performance Verification

Test record for DSI master clock output frequency accuracy verification

Word length	Sampling rate (Hz)	Master clock multiplier (MUL)	Master clock rate (MCLK)	Measurement 1	Measurement 2	F _{measure} (Hz)	F _{error} (ppm)
8	6750	128	864000				
8	6750	256	1728000				
8	6750	512	3456000				
8	6750	1024	6912000				
8	8000	128	1024000				
8	8000	256	2048000				
8	8000	512	4096000				
8	8000	1024	8192000				
8	11030	128	1411840				
8	11030	256	2823680				
8	11030	512	5647360				
8	11030	1024	11294720				
8	12500	128	1600000				
8	12500	256	3200000				
8	12500	512	6400000				
8	12500	1024	12800000				
8	13000	128	1664000				
8	13000	256	3328000				
8	13000	512	6656000				

Word length	Sampling rate (Hz)	Master clock multiplier (MUL)	Master clock rate (MCLK)	Measurement 1	Measurement 2	F _{measure} (Hz)	F _{error} (ppm)
8	13000	1024	13312000				
8	16000	128	2048000				
8	16000	256	4096000				
8	16000	512	8192000				
8	16000	1024	16384000				
8	22050	128	2822400				
8	22050	256	5644800				
8	22050	512	11289600				
8	22050	1024	22579200				
8	25000	128	3200000				
8	25000	256	6400000				
8	25000	512	12800000				
8	25000	1024	25600000				
8	30000	128	3840000				
8	30000	256	7680000				
8	30000	512	15360000				
8	32000	128	4096000				
8	32000	256	8192000				
8	32000	512	16384000				
8	44100	128	5644800				
8	44100	256	11289600				
8	44100	512	22579200				
8	48000	128	6144000				
8	48000	256	12288000				
8	48000	512	24576000				

B Appendix B

Digital Generator and Analyzer Performance Verification

Word length	Sampling rate (Hz)	Master clock multiplier (MUL)	Master clock rate (MCLK)	Measurement 1	Measurement 2	F _{measure} (Hz)	F _{error} (ppm)
8	50000	128	6400000				
8	50000	256	12800000				
8	50000	512	25600000				
8	55000	128	7040000				
8	55000	256	14080000				
8	88200	128	11289600				
8	88200	256	22579200				
8	96000	128	12288000				
8	96000	256	24576000				
8	100000	128	12800000				
8	100000	256	25600000				
8	150000	128	19200000				
8	176400	128	22579200				
8	192000	128	24576000				
8	200000	128	25600000				
12	6750	96	648000				
12	6750	192	1296000				
12	6750	384	2592000				
12	6750	768	5184000				
12	8000	96	768000				
12	8000	192	1536000				
12	8000	384	3072000				
12	8000	768	6144000				
12	11030	96	1058880				
12	11030	192	2117760				

Word length	Sampling rate (Hz)	Master clock multiplier (MUL)	Master clock rate (MCLK)	Measurement 1	Measurement 2	F _{measure} (Hz)	F _{error} (ppm)
12	11030	384	4235520				
12	11030	768	8471040				
12	12500	96	1200000				
12	12500	192	2400000				
12	12500	384	4800000				
12	12500	768	9600000				
12	13000	96	1248000				
12	13000	192	2496000				
12	13000	384	4992000				
12	13000	768	9984000				
12	16000	96	1536000				
12	16000	192	3072000				
12	16000	384	6144000				
12	16000	768	12288000				
12	22050	96	2116800				
12	22050	192	4233600				
12	22050	384	8467200				
12	22050	768	16934400				
12	25000	96	2400000				
12	25000	192	4800000				
12	25000	384	9600000				
12	25000	768	19200000				
12	30000	96	2880000				
12	30000	192	5760000				
12	30000	384	11520000				

B Appendix B

Digital Generator and Analyzer Performance Verification

Word length	Sampling rate (Hz)	Master clock multiplier (MUL)	Master clock rate (MCLK)	Measurement 1	Measurement 2	F _{measure} (Hz)	F _{error} (ppm)
12	30000	768	23040000				
12	32000	96	3072000				
12	32000	192	6144000				
12	32000	384	12288000				
12	32000	768	24576000				
12	44100	96	4233600				
12	44100	192	8467200				
12	44100	384	16934400				
12	44100	768	33868800				
12	48000	96	4608000				
12	48000	192	9216000				
12	48000	384	18432000				
12	48000	768	36864000				
12	50000	96	4800000				
12	50000	192	9600000				
12	50000	384	19200000				
12	50000	768	38400000				
12	55000	96	5280000				
12	55000	192	10560000				
12	55000	384	21120000				
12	88200	96	8467200				
12	88200	192	16934400				
12	88200	384	33868800				
12	96000	96	9216000				
12	96000	192	18432000				

Word length	Sampling rate (Hz)	Master clock multiplier (MUL)	Master clock rate (MCLK)	Measurement 1	Measurement 2	F _{measure} (Hz)	F _{error} (ppm)
12	96000	384	36864000				
12	100000	96	9600000				
12	100000	192	19200000				
12	100000	384	38400000				
12	150000	96	14400000				
12	150000	192	28800000				
12	176400	96	16934400				
12	176400	192	33868800				
12	192000	96	18432000				
12	192000	192	36864000				
12	200000	96	19200000				
12	200000	192	38400000				
12	250000	96	24000000				
12	384000	96	36864000				
12	400000	96	38400000				
16	6750	128	864000				
16	6750	256	1728000				
16	6750	512	3456000				
16	8000	64	512000				
16	8000	128	1024000				
16	8000	256	2048000				
16	8000	512	4096000				
16	11030	64	705920				
16	11030	128	1411840				
16	11030	256	2823680				

B Appendix B

Digital Generator and Analyzer Performance Verification

Word length	Sampling rate (Hz)	Master clock multiplier (MUL)	Master clock rate (MCLK)	Measurement 1	Measurement 2	F _{measure} (Hz)	F _{error} (ppm)
16	11030	512	5647360				
16	12500	64	800000				
16	12500	128	1600000				
16	12500	256	3200000				
16	12500	512	6400000				
16	13000	64	832000				
16	13000	128	1664000				
16	13000	256	3328000				
16	13000	512	6656000				
16	16000	64	1024000				
16	16000	128	2048000				
16	16000	256	4096000				
16	16000	512	8192000				
16	22050	64	1411200				
16	22050	128	2822400				
16	22050	256	5644800				
16	22050	512	11289600				
16	25000	64	1600000				
16	25000	128	3200000				
16	25000	256	6400000				
16	25000	512	12800000				
16	30000	64	1920000				
16	30000	128	3840000				
16	30000	256	7680000				
16	30000	512	15360000				

Word length	Sampling rate (Hz)	Master clock multiplier (MUL)	Master clock rate (MCLK)	Measurement 1	Measurement 2	F _{measure} (Hz)	F _{error} (ppm)
16	32000	64	2048000				
16	32000	128	4096000				
16	32000	256	8192000				
16	32000	512	16384000				
16	44100	64	2822400				
16	44100	128	5644800				
16	44100	256	11289600				
16	44100	512	22579200				
16	48000	64	3072000				
16	48000	128	6144000				
16	48000	256	12288000				
16	48000	512	24576000				
16	50000	64	3200000				
16	50000	128	6400000				
16	50000	256	12800000				
16	50000	512	25600000				
16	55000	64	3520000				
16	55000	128	7040000				
16	55000	256	14080000				
16	88200	64	5644800				
16	88200	128	11289600				
16	88200	256	22579200				
16	96000	64	6144000				
16	96000	128	12288000				
16	96000	256	24576000				

B Appendix B

Digital Generator and Analyzer Performance Verification

Word length	Sampling rate (Hz)	Master clock multiplier (MUL)	Master clock rate (MCLK)	Measurement 1	Measurement 2	F _{measure} (Hz)	F _{error} (ppm)
16	100000	64	6400000				
16	100000	128	12800000				
16	100000	256	25600000				
16	150000	64	9600000				
16	150000	128	19200000				
16	176400	64	11289600				
16	176400	128	22579200				
16	192000	64	12288000				
16	192000	128	24576000				
16	200000	64	12800000				
16	200000	128	25600000				
16	250000	64	16000000				
16	384000	64	24576000				
16	400000	64	25600000				
20	6750	160	1080000				
20	6750	320	2160000				
20	6750	640	4320000				
20	8000	80	640000				
20	8000	160	1280000				
20	8000	320	2560000				
20	8000	640	5120000				
20	11030	80	882400				
20	11030	160	1764800				
20	11030	320	3529600				
20	11030	640	7059200				

Word length	Sampling rate (Hz)	Master clock multiplier (MUL)	Master clock rate (MCLK)	Measurement 1	Measurement 2	F _{measure} (Hz)	F _{error} (ppm)
20	12500	80	1000000				
20	12500	160	2000000				
20	12500	320	4000000				
20	12500	640	8000000				
20	13000	80	1040000				
20	13000	160	2080000				
20	13000	320	4160000				
20	13000	640	8320000				
20	16000	80	1280000				
20	16000	160	2560000				
20	16000	320	5120000				
20	16000	640	10240000				
20	22050	80	1764000				
20	22050	160	3528000				
20	22050	320	7056000				
20	22050	640	14112000				
20	25000	80	2000000				
20	25000	160	4000000				
20	25000	320	8000000				
20	25000	640	16000000				
20	30000	80	2400000				
20	30000	160	4800000				
20	30000	320	9600000				
20	30000	640	19200000				
20	32000	80	2560000				

B Appendix B

Digital Generator and Analyzer Performance Verification

Word length	Sampling rate (Hz)	Master clock multiplier (MUL)	Master clock rate (MCLK)	Measurement 1	Measurement 2	F _{measure} (Hz)	F _{error} (ppm)
20	32000	160	5120000				
20	32000	320	10240000				
20	32000	640	20480000				
20	44100	80	3528000				
20	44100	160	7056000				
20	44100	320	14112000				
20	44100	640	28224000				
20	48000	80	3840000				
20	48000	160	7680000				
20	48000	320	15360000				
20	48000	640	30720000				
20	50000	80	4000000				
20	50000	160	8000000				
20	50000	320	16000000				
20	50000	640	32000000				
20	55000	80	4400000				
20	55000	160	8800000				
20	55000	320	17600000				
20	88200	80	7056000				
20	88200	160	14112000				
20	88200	320	28224000				
20	96000	80	7680000				
20	96000	160	15360000				
20	96000	320	30720000				
20	100000	80	8000000				

Word length	Sampling rate (Hz)	Master clock multiplier (MUL)	Master clock rate (MCLK)	Measurement 1	Measurement 2	F _{measure} (Hz)	F _{error} (ppm)
20	100000	160	16000000				
20	100000	320	32000000				
20	150000	80	12000000				
20	150000	160	24000000				
20	176400	80	14112000				
20	176400	160	28224000				
20	192000	80	15360000				
20	192000	160	30720000				
20	200000	80	16000000				
20	200000	160	32000000				
20	250000	80	20000000				
20	384000	80	30720000				
20	400000	80	32000000				
24	6750	192	1296000				
24	6750	384	2592000				
24	6750	768	5184000				
24	8000	96	768000				
24	8000	192	1536000				
24	8000	384	3072000				
24	8000	768	6144000				
24	11030	96	1058880				
24	11030	192	2117760				
24	11030	384	4235520				
24	11030	768	8471040				
24	12500	96	1200000				

B Appendix B

Digital Generator and Analyzer Performance Verification

Word length	Sampling rate (Hz)	Master clock multiplier (MUL)	Master clock rate (MCLK)	Measurement 1	Measurement 2	F _{measure} (Hz)	F _{error} (ppm)
24	12500	192	2400000				
24	12500	384	4800000				
24	12500	768	9600000				
24	13000	96	1248000				
24	13000	192	2496000				
24	13000	384	4992000				
24	13000	768	9984000				
24	16000	96	1536000				
24	16000	192	3072000				
24	16000	384	6144000				
24	16000	768	12288000				
24	22050	96	2116800				
24	22050	192	4233600				
24	22050	384	8467200				
24	22050	768	16934400				
24	25000	96	2400000				
24	25000	192	4800000				
24	25000	384	9600000				
24	25000	768	19200000				
24	30000	96	2880000				
24	30000	192	5760000				
24	30000	384	11520000				
24	30000	768	23040000				
24	32000	96	3072000				
24	32000	192	6144000				

Word length	Sampling rate (Hz)	Master clock multiplier (MUL)	Master clock rate (MCLK)	Measurement 1	Measurement 2	F _{measure} (Hz)	F _{error} (ppm)
24	32000	384	12288000				
24	32000	768	24576000				
24	44100	96	4233600				
24	44100	192	8467200				
24	44100	384	16934400				
24	44100	768	33868800				
24	48000	96	4608000				
24	48000	192	9216000				
24	48000	384	18432000				
24	48000	768	36864000				
24	50000	96	4800000				
24	50000	192	9600000				
24	50000	384	19200000				
24	50000	768	38400000				
24	55000	96	5280000				
24	55000	192	10560000				
24	55000	384	21120000				
24	88200	96	8467200				
24	88200	192	16934400				
24	88200	384	33868800				
24	96000	96	9216000				
24	96000	192	18432000				
24	96000	384	36864000				
24	100000	96	9600000				
24	100000	192	19200000				

B Appendix B

Digital Generator and Analyzer Performance Verification

Word length	Sampling rate (Hz)	Master clock multiplier (MUL)	Master clock rate (MCLK)	Measurement 1	Measurement 2	F _{measure} (Hz)	F _{error} (ppm)
24	100000	384	38400000				
24	150000	96	14400000				
24	150000	192	28800000				
24	176400	96	16934400				
24	176400	192	33868800				
24	192000	96	18432000				
24	192000	192	36864000				
24	200000	96	19200000				
24	200000	192	38400000				
24	250000	96	24000000				
24	384000	96	36864000				
24	400000	96	38400000				
28	6750	224	1512000				
28	6750	448	3024000				
28	6750	896	6048000				
28	8000	112	896000				
28	8000	224	1792000				
28	8000	448	3584000				
28	8000	896	7168000				
28	11030	112	1235360				
28	11030	224	2470720				
28	11030	448	4941440				
28	11030	896	9882880				
28	12500	112	1400000				
28	12500	224	2800000				

Word length	Sampling rate (Hz)	Master clock multiplier (MUL)	Master clock rate (MCLK)	Measurement 1	Measurement 2	F _{measure} (Hz)	F _{error} (ppm)
28	12500	448	5600000				
28	12500	896	11200000				
28	13000	112	1456000				
28	13000	224	2912000				
28	13000	448	5824000				
28	13000	896	11648000				
28	16000	112	1792000				
28	16000	224	3584000				
28	16000	448	7168000				
28	16000	896	14336000				
28	22050	112	2469600				
28	22050	224	4939200				
28	22050	448	9878400				
28	22050	896	19756800				
28	25000	112	2800000				
28	25000	224	5600000				
28	25000	448	11200000				
28	25000	896	22400000				
28	30000	112	3360000				
28	30000	224	6720000				
28	30000	448	13440000				
28	30000	896	26880000				
28	32000	112	3584000				
28	32000	224	7168000				
28	32000	448	14336000				

B Appendix B

Digital Generator and Analyzer Performance Verification

Word length	Sampling rate (Hz)	Master clock multiplier (MUL)	Master clock rate (MCLK)	Measurement 1	Measurement 2	F _{measure} (Hz)	F _{error} (ppm)
28	32000	896	28672000				
28	44100	112	4939200				
28	44100	224	9878400				
28	44100	448	19756800				
28	44100	896	39513600				
28	48000	112	5376000				
28	48000	224	10752000				
28	48000	448	21504000				
28	48000	896	43008000				
28	50000	112	5600000				
28	50000	224	11200000				
28	50000	448	22400000				
28	50000	896	44800000				
28	55000	112	6160000				
28	55000	224	12320000				
28	55000	448	24640000				
28	88200	112	9878400				
28	88200	224	19756800				
28	88200	448	39513600				
28	96000	112	10752000				
28	96000	224	21504000				
28	96000	448	43008000				
28	100000	112	11200000				
28	100000	224	22400000				
28	100000	448	44800000				

Word length	Sampling rate (Hz)	Master clock multiplier (MUL)	Master clock rate (MCLK)	Measurement 1	Measurement 2	F _{measure} (Hz)	F _{error} (ppm)
28	150000	112	16800000				
28	150000	224	33600000				
28	176400	112	19756800				
28	176400	224	39513600				
28	192000	112	21504000				
28	192000	224	43008000				
28	200000	112	22400000				
28	200000	224	44800000				
28	250000	112	28000000				
28	384000	112	43008000				
28	400000	112	44800000				
32	6750	128	864000				
32	6750	256	1728000				
32	6750	512	3456000				
32	6750	1024	6912000				
32	8000	128	1024000				
32	8000	256	2048000				
32	8000	512	4096000				
32	8000	1024	8192000				
32	11030	128	1411840				
32	11030	256	2823680				
32	11030	512	5647360				
32	11030	1024	11294720				
32	12500	128	1600000				
32	12500	256	3200000				

B Appendix B

Digital Generator and Analyzer Performance Verification

Word length	Sampling rate (Hz)	Master clock multiplier (MUL)	Master clock rate (MCLK)	Measurement 1	Measurement 2	F _{measure} (Hz)	F _{error} (ppm)
32	12500	512	6400000				
32	12500	1024	12800000				
32	13000	128	1664000				
32	13000	256	3328000				
32	13000	512	6656000				
32	13000	1024	13312000				
32	16000	128	2048000				
32	16000	256	4096000				
32	16000	512	8192000				
32	16000	1024	16384000				
32	22050	128	2822400				
32	22050	256	5644800				
32	22050	512	11289600				
32	22050	1024	22579200				
32	25000	128	3200000				
32	25000	256	6400000				
32	25000	512	12800000				
32	25000	1024	25600000				
32	30000	128	3840000				
32	30000	256	7680000				
32	30000	512	15360000				
32	32000	128	4096000				
32	32000	256	8192000				
32	32000	512	16384000				
32	44100	128	5644800				

Word length	Sampling rate (Hz)	Master clock multiplier (MUL)	Master clock rate (MCLK)	Measurement 1	Measurement 2	F _{measure} (Hz)	F _{error} (ppm)
32	44100	256	11289600				
32	44100	512	22579200				
32	48000	128	6144000				
32	48000	256	12288000				
32	48000	512	24576000				
32	50000	128	6400000				
32	50000	256	12800000				
32	50000	512	25600000				
32	55000	128	7040000				
32	55000	256	14080000				
32	88200	128	11289600				
32	88200	256	22579200				
32	96000	128	12288000				
32	96000	256	24576000				
32	100000	128	12800000				
32	100000	256	25600000				
32	150000	128	19200000				
32	176400	128	22579200				
32	192000	128	24576000				
32	200000	128	25600000				

B Appendix B

Digital Generator and Analyzer Performance Verification

Test record for optical input sampling rate accuracy verification

Sampling rate (kHz)	F _{measure} (kHz)	F _{error} (ppm)
28.8		
30		
35		
40		
44.1		
50		
55		
60		
65		
70		
75		
80		
85		
88.2		
92		
96		
100		
105		
110		
115		
120		
125		
130		

Sampling rate (kHz)	F _{measure} (kHz)	F _{error} (ppm)
135		
140		
145		
150		
155		
160		
165		
170		
176.4		
180		
185		
190		
192		

Test record for balanced input sampling rate accuracy verification

Sampling rate (kHz)	Impedance	F _{measure} (kHz)	F _{error} (ppm)
28.8	Low		
30	Low		
35	Low		
40	Low		
44.1	Low		
50	Low		
55	Low		

B Appendix B

Digital Generator and Analyzer Performance Verification

Sampling rate (kHz)	Impedance	F_{measure} (kHz)	F_{error} (ppm)
60	Low		
65	Low		
70	Low		
75	Low		
80	Low		
85	Low		
88.2	Low		
92	Low		
96	Low		
100	Low		
105	Low		
110	Low		
115	Low		
120	Low		
125	Low		
130	Low		
135	Low		
140	Low		
145	Low		
150	Low		
155	Low		
160	Low		
165	Low		
170	Low		
176.4	Low		
180	Low		

Digital Generator and Analyzer Performance Verification

Sampling rate (kHz)	Impedance	F _{measure} (kHz)	F _{error} (ppm)
185	Low		
190	Low		
192	Low		
28.8	High		
30	High		
35	High		
40	High		
44.1	High		
50	High		
55	High		
60	High		
65	High		
70	High		
75	High		
80	High		
85	High		
88.2	High		
92	High		
96	High		
100	High		
105	High		
110	High		
115	High		
120	High		
125	High		
130	High		

B Appendix B

Digital Generator and Analyzer Performance Verification

Sampling rate (kHz)	Impedance	F _{measure} (kHz)	F _{error} (ppm)
135	High		
140	High		
145	High		
150	High		
155	High		
160	High		
165	High		
170	High		
176.4	High		
180	High		
185	High		
190	High		
192	High		

Test record for balanced output level accuracy verification

Sampling rate (kHz)	V _{DUT} (V)	V _{measure} (V)	Level accuracy (dB)
28.8	0.3		
28.8	0.5		
28.8	0.8		
28.8	1		
28.8	1.2		
28.8	1.3		
28.8	1.5		
28.8	1.8		

Digital Generator and Analyzer Performance Verification

Sampling rate (kHz)	V_{DUT} (V)	$V_{measure}$ (V)	Level accuracy (dB)
28.8	2		
28.8	2.3		
28.8	2.5		
28.8	2.8		
28.8	3		
28.8	3.3		
28.8	3.5		
28.8	3.8		
28.8	4		
28.8	4.3		
28.8	4.5		
28.8	4.8		
28.8	5.1		
32	0.3		
32	0.5		
32	0.8		
32	1		
32	1.2		
32	1.3		
32	1.5		
32	1.8		
32	2		
32	2.3		
32	2.5		
32	2.8		
32	3		

B Appendix B

Digital Generator and Analyzer Performance Verification

Sampling rate (kHz)	V _{DUT} (V)	V _{measure} (V)	Level accuracy (dB)
32	3.3		
32	3.5		
32	3.8		
32	4		
32	4.3		
32	4.5		
32	4.8		
32	5.1		
44.1	0.3		
44.1	0.5		
44.1	0.8		
44.1	1		
44.1	1.2		
44.1	1.3		
44.1	1.5		
44.1	1.8		
44.1	2		
44.1	2.3		
44.1	2.5		
44.1	2.8		
44.1	3		
44.1	3.3		
44.1	3.5		
44.1	3.8		
44.1	4		
44.1	4.3		

Digital Generator and Analyzer Performance Verification

Sampling rate (kHz)	V_{DUT} (V)	$V_{measure}$ (V)	Level accuracy (dB)
44.1	4.5		
44.1	4.8		
44.1	5.1		
48	0.3		
48	0.5		
48	0.8		
48	1		
48	1.2		
48	1.3		
48	1.5		
48	1.8		
48	2		
48	2.3		
48	2.5		
48	2.8		
48	3		
48	3.3		
48	3.5		
48	3.8		
48	4		
48	4.3		
48	4.5		
48	4.8		
48	5.1		
88.2	0.3		
88.2	0.5		

B Appendix B

Digital Generator and Analyzer Performance Verification

Sampling rate (kHz)	V _{DUT} (V)	V _{measure} (V)	Level accuracy (dB)
88.2	0.8		
88.2	1		
88.2	1.2		
88.2	1.3		
88.2	1.5		
88.2	1.8		
88.2	2		
88.2	2.3		
88.2	2.5		
88.2	2.8		
88.2	3		
88.2	3.3		
88.2	3.5		
88.2	3.8		
88.2	4		
88.2	4.3		
88.2	4.5		
88.2	4.8		
88.2	5.1		
96	0.3		
96	0.5		
96	0.8		
96	1		
96	1.2		
96	1.3		
96	1.5		

Digital Generator and Analyzer Performance Verification

Sampling rate (kHz)	V_{DUT} (V)	$V_{measure}$ (V)	Level accuracy (dB)
96	1.8		
96	2		
96	2.3		
96	2.5		
96	2.8		
96	3		
96	3.3		
96	3.5		
96	3.8		
96	4		
96	4.3		
96	4.5		
96	4.8		
96	5.1		
176.4	0.3		
176.4	0.5		
176.4	0.8		
176.4	1		
176.4	1.2		
176.4	1.3		
176.4	1.5		
176.4	1.8		
176.4	2		
176.4	2.3		
176.4	2.5		
176.4	2.8		

B Appendix B

Digital Generator and Analyzer Performance Verification

Sampling rate (kHz)	V _{DUT} (V)	V _{measure} (V)	Level accuracy (dB)
176.4	3		
176.4	3.3		
176.4	3.5		
176.4	3.8		
176.4	4		
176.4	4.3		
176.4	4.5		
176.4	4.8		
176.4	5.1		
192	0.3		
192	0.5		
192	0.8		
192	1		
192	1.2		
192	1.3		
192	1.5		
192	1.8		
192	2		
192	2.3		
192	2.5		
192	2.8		
192	3		
192	3.3		
192	3.5		
192	3.8		
192	4		

Sampling rate (kHz)	V_{DUT} (V)	$V_{measure}$ (V)	Level accuracy (dB)
192	4.3		
192	4.5		
192	4.8		
192	5.1		

Test record for balanced output sampling rate accuracy verification

Sampling rate (kHz)	$F_{measure}$ (kHz)	F_{error} (ppm)
28.8		
30		
35		
40		
44.1		
50		
55		
60		
65		
70		
75		
80		
85		
88.2		
92		
96		

B Appendix B

Digital Generator and Analyzer Performance Verification

Sampling rate (kHz)	F _{measure} (kHz)	F _{error} (ppm)
100		
105		
110		
115		
120		
125		
130		
135		
140		
145		
150		
155		
160		
165		
170		
176.4		
180		
185		
190		
192		

Test record for unbalanced input sampling rate accuracy verification

Sampling rate (kHz)	Impedance	F _{measure} (kHz)	F _{error} (ppm)
28.8	Low		
30	Low		
35	Low		
40	Low		
44.1	Low		
50	Low		
55	Low		
60	Low		
65	Low		
70	Low		
75	Low		
80	Low		
85	Low		
88.2	Low		
92	Low		
96	Low		
100	Low		
105	Low		
110	Low		
115	Low		
120	Low		
125	Low		
130	Low		

B Appendix B

Digital Generator and Analyzer Performance Verification

Sampling rate (kHz)	Impedance	F _{measure} (kHz)	F _{error} (ppm)
135	Low		
140	Low		
145	Low		
150	Low		
155	Low		
160	Low		
165	Low		
170	Low		
176.4	Low		
180	Low		
185	Low		
190	Low		
192	Low		
28.8	High		
30	High		
35	High		
40	High		
44.1	High		
50	High		
55	High		
60	High		
65	High		
70	High		
75	High		
80	High		
85	High		

Digital Generator and Analyzer Performance Verification

Sampling rate (kHz)	Impedance	F_{measure} (kHz)	F_{error} (ppm)
88.2	High		
92	High		
96	High		
100	High		
105	High		
110	High		
115	High		
120	High		
125	High		
130	High		
135	High		
140	High		
145	High		
150	High		
155	High		
160	High		
165	High		
170	High		
176.4	High		
180	High		
185	High		
190	High		
192	High		

B Appendix B

Digital Generator and Analyzer Performance Verification

Test record for unbalanced output level accuracy verification

Sampling rate (kHz)	V_{DUT} (V)	$V_{measure}$ (V)	Level accuracy (dB)
28.8	0.3		
28.8	0.5		
28.8	0.8		
28.8	1		
28.8	1.2		
28.8	1.3		
28.8	1.5		
28.8	1.8		
28.8	2		
28.8	2.3		
28.8	2.5		
28.8	2.8		
28.8	3		
28.8	3.3		
28.8	3.5		
28.8	3.8		
28.8	4		
28.8	4.3		
28.8	4.5		
28.8	4.8		
28.8	5.1		
32	0.3		
32	0.5		
32	0.8		

Digital Generator and Analyzer Performance Verification

Sampling rate (kHz)	V_{DUT} (V)	$V_{measure}$ (V)	Level accuracy (dB)
32	1		
32	1.2		
32	1.3		
32	1.5		
32	1.8		
32	2		
32	2.3		
32	2.5		
32	2.8		
32	3		
32	3.3		
32	3.5		
32	3.8		
32	4		
32	4.3		
32	4.5		
32	4.8		
32	5.1		
44.1	0.3		
44.1	0.5		
44.1	0.8		
44.1	1		
44.1	1.2		
44.1	1.3		
44.1	1.5		
44.1	1.8		

B Appendix B

Digital Generator and Analyzer Performance Verification

Sampling rate (kHz)	V_{DUT} (V)	$V_{measure}$ (V)	Level accuracy (dB)
44.1	2		
44.1	2.3		
44.1	2.5		
44.1	2.8		
44.1	3		
44.1	3.3		
44.1	3.5		
44.1	3.8		
44.1	4		
44.1	4.3		
44.1	4.5		
44.1	4.8		
44.1	5.1		
48	0.3		
48	0.5		
48	0.8		
48	1		
48	1.2		
48	1.3		
48	1.5		
48	1.8		
48	2		
48	2.3		
48	2.5		
48	2.8		
48	3		

Digital Generator and Analyzer Performance Verification

Sampling rate (kHz)	V_{DUT} (V)	$V_{measure}$ (V)	Level accuracy (dB)
48	3.3		
48	3.5		
48	3.8		
48	4		
48	4.3		
48	4.5		
48	4.8		
48	5.1		
88.2	0.3		
88.2	0.5		
88.2	0.8		
88.2	1		
88.2	1.2		
88.2	1.3		
88.2	1.5		
88.2	1.8		
88.2	2		
88.2	2.3		
88.2	2.5		
88.2	2.8		
88.2	3		
88.2	3.3		
88.2	3.5		
88.2	3.8		
88.2	4		
88.2	4.3		

B Appendix B

Digital Generator and Analyzer Performance Verification

Sampling rate (kHz)	V_{DUT} (V)	$V_{measure}$ (V)	Level accuracy (dB)
88.2	4.5		
88.2	4.8		
88.2	5.1		
96	0.3		
96	0.5		
96	0.8		
96	1		
96	1.2		
96	1.3		
96	1.5		
96	1.8		
96	2		
96	2.3		
96	2.5		
96	2.8		
96	3		
96	3.3		
96	3.5		
96	3.8		
96	4		
96	4.3		
96	4.5		
96	4.8		
96	5.1		
176.4	0.3		
176.4	0.5		

Digital Generator and Analyzer Performance Verification

Sampling rate (kHz)	V_{DUT} (V)	$V_{measure}$ (V)	Level accuracy (dB)
176.4	0.8		
176.4	1		
176.4	1.2		
176.4	1.3		
176.4	1.5		
176.4	1.8		
176.4	2		
176.4	2.3		
176.4	2.5		
176.4	2.8		
176.4	3		
176.4	3.3		
176.4	3.5		
176.4	3.8		
176.4	4		
176.4	4.3		
176.4	4.5		
176.4	4.8		
176.4	5.1		
192	0.3		
192	0.5		
192	0.8		
192	1		
192	1.2		
192	1.3		
192	1.5		

B Appendix B

Digital Generator and Analyzer Performance Verification

Sampling rate (kHz)	V _{DUT} (V)	V _{measure} (V)	Level accuracy (dB)
192	1.8		
192	2		
192	2.3		
192	2.5		
192	2.8		
192	3		
192	3.3		
192	3.5		
192	3.8		
192	4		
192	4.3		
192	4.5		
192	4.8		
192	5.1		

Test record for unbalanced output sampling rate accuracy verification

Sampling rate (kHz)	F _{measure} (kHz)	F _{error} (ppm)
28.8		
30		
35		
40		
44.1		
50		

Digital Generator and Analyzer Performance Verification

Sampling rate (kHz)	F _{measure} (kHz)	F _{error} (ppm)
55		
60		
65		
70		
75		
80		
85		
88.2		
92		
96		
100		
105		
110		
115		
120		
125		
130		
135		
140		
145		
150		
155		
160		
165		
170		
176.4		

B Appendix B

Digital Generator and Analyzer Performance Verification

Sampling rate (kHz)	F _{measure} (kHz)	F _{error} (ppm)
180		
185		
190		
192		

www.agilent.com

Contact us

To obtain service, warranty, or technical assistance, contact us at the following phone or fax numbers:

United States:

(tel) 800 829 4444 (fax) 800 829 4433

Canada:

(tel) 877 894 4414 (fax) 800 746 4866

China:

(tel) 800 810 0189 (fax) 800 820 2816

Europe:

(tel) 31 20 547 2111

Japan:

(tel) 0120 (421) 345 (fax) 0120 421 678

Korea:

(tel) (080) 769 0800 (fax) (080) 769 0900

Latin America:

(tel) (305) 269 7500

Taiwan:

(tel) 0800 047 866 (fax) 0800 286 331

Other Asia Pacific Countries:

(tel) (65) 6375 8100 (fax) (65) 6755 0042

Or visit Agilent World Wide Web at:

www.agilent.com/find/assist

Product specifications and descriptions in this document are subject to change without notice. Always refer to Agilent Web site for the latest revision.

© Agilent Technologies, Inc., 2009-2012

Third Edition, February 17, 2012
U8903-90029



Agilent Technologies